

The Roots of Verbs

by

Lisa Levinson

A dissertation submitted in partial fulfillment

of the requirements for the degree of

Doctor of Philosophy

Department of Linguistics

New York University

September, 2007

Richard S. Kayne —Advisor

Liina Pykkänen —Advisor

Dedication

This dissertation is dedicated to my grandmothers,

Janet Levinson and Rhoda Schechter,

and to the memory of my grandfathers,

David Levinson and Elliott Schechter,

always in my heart.

Acknowledgments

I feel extremely fortunate to have had such an amazing dissertation committee. The comments, questions, criticism, and support that they offered throughout this project were truly invaluable. I would like to thank my co-advisors, Richie Kayne and Liina Pykkänen for guiding me throughout the project and always bringing me back to the important questions. I am very grateful for the fact that my other committee members, Chris Barker, Marcel den Dikken, and Alec Marantz, were also always eager and available to talk with me about the project, and I only wish I could have availed myself more often of their insight. Special thanks to Chris Barker for stepping in at the last moment and still managing to provide such useful suggestions. All of the members of my committee have inspired me not only in matters linguistic, but in providing models of what it means to be a stellar researcher. I hope some of their influence has rubbed off on me!

There are so many others who provided me both with academic and moral support throughout graduate school. I can't imagine what these five years would have been like without my beloved officemates and dear friends, Tom Leu, Oana Savescu-Ciucivara, and Eytan Zweig. I will always remember our cramped little office and the times spent there fondly. I'll also miss the times spent in the syntax/semantics lab, talking life and linguistics and drawing it all on the blackboard, graced from time by the presence of Lena Baunaz, Andrea Cattaneo, Suzanne Dikker, Bill Haddican, Hugh Rabagliati, and Laura Rimell. Our department administrator, Lorraine Jerome, always kept department life running smoothly, and went out of her way to help me on more than one occasion. I'm also very grateful for the linguists who were always up for a beer and a good discussion at the end of a long conference day, including Carlos de Cuba, Alison Gabriele, Susana

Huidobro, Alexia Ioannidou, Jason Kandybowicz, Jonathan MacDonald, Lanko Marusic, Dorian Roehrs, Stephanie Solt, Rachel Szekely, Erika Troseth, Chris Warnasch, and Hedde Zeijlstra.

I would also like to thank those not yet mentioned above who contributed their feedback and linguistic judgments to this work, including David Adger, Arto Anttila, Yukiko Asano, Chris Collins, David Embick, Ken Hiraiwa, Jaume Mateu, Øystein Nilsen, Anna Szabolcsi, and the audiences at LSA 2007, GLOW 29, PLC 30, and the LANYU Forum.

At least as important to this project were my non-linguist friends, who among other things have reminded me that there is so much more out there, and were always there with open arms and ears. Thank you to Karina Attar, Molly Belmont, Zane Mackin, Devon McConnell, Dave Megathlin, Stefan Pedatella, and Lytton Smith for your love and support.

I couldn't have done this at all if it weren't for my family, who have always thought that I could do anything I set out to do, even when I tried to convince them otherwise. Thanks especially to my mom, Susan (the 'first' Dr. Levinson), my dad, Barry Levinson, my sister, Ashley Levinson, and my step-father, Bob Agrusti, for always being there.

Finally, I'd like to thank Jon Brennan, who has supported me pretty much every day, in every way imaginable throughout these dissertation years. I cannot pretend to sufficiently express the depth of my gratitude for his constant love and support. I might have managed to make it through these years without him, but they certainly wouldn't have been as rich.

Abstract

Theories of lexical semantics and syntactic decomposition usually make a distinction between the role of the ‘idiosyncratic’ lexical component of words, the ‘constant’ or ‘root’, and that of the functional elements which are shared between different members of a word class. Understanding the properties of such lexical building blocks is central to our understanding of language. However, most work thus far has focused on the functional building blocks. In particular, there has been little work addressing the formal semantics of lexical roots. In this dissertation, I focus on a particular class of verbs, implicit creation verbs, and argue that these are derived from roots which denote predicates of individuals. These verbs are contrasted with verbs derived from roots of different types, toward the goal of developing a complete ontology of roots. I argue that many of the generalizations derived in other work from syntactic categories can in fact be derived from semantic root type. The analysis presented for the compositional construction of verbs has consequences for the nature of lexical decomposition, the analysis of resultative secondary predicates, the analysis of verb particles, and the relationship between syntactic and semantic categories.

Contents

Dedication	iii
Acknowledgments	iv
Abstract	vi
List of Figures	xii
List of Tables	xiii
1 Introduction	1
1.1 Lexical Decomposition in Linguistic Theory	5
1.1.1 Semantic Lexical Decomposition	6
1.1.1.1 Decomposition for Event Structure	6
1.1.1.2 Decomposition for Argument Structure	8
1.1.1.3 Semantic Decomposition and Root Ontology	8
1.1.2 Syntactic Lexical Decomposition	9
1.1.2.1 Lexical Decomposition and Lexical Category	10
1.1.3 Open Questions in the Literature on Decomposition	11
1.1.4 Summary of the Dissertation	12
1.2 Assumptions and Framework	13
1.3 Structure of the Dissertation	15

2	The Semantic Role of Individual-Predicate Roots in Verbal Derivation	16
2.1	Implicit Creation Verbs	17
2.2	Role of the Root	20
2.2.1	Root Type and Telicity	21
2.2.2	Aspectual Impact of the Roots of Implicit Creation Verbs	27
2.3	Relation of Pseudo-Resultative Predicates to the Root	31
2.3.1	Pseudo-Resultative Modifiers	31
2.3.2	Not Object DP Modifiers	33
2.3.3	Not Predicates of Events	36
2.3.4	Geuder's Account for Resultative Adverbs	39
2.3.5	Redefining Implicit Creation Verbs	42
2.3.6	Proposal: Root Modification	43
2.4	Relation of the Root to the Object DP	45
2.4.1	Locative Semantics	48
2.4.2	Adding a State	52
2.4.2.1	Semantics of Locative PPs	52
2.4.2.2	Semantics of <i>re</i> -Prefixation	53
2.4.2.3	Compositionally Adding the State	58
2.5	Relation of the Root to the Event	61
2.6	Summary	64
3	The Syntax of Roots and Root Modification	65
3.1	Syntax of Root Modification	66
3.1.1	Category of the Pseudo-Resultative Predicate: Against the Adverb Hypothesis	67
3.1.1.1	Pseudo-Resultative Predicate is Adjectival	68

3.1.1.1.1	Catalan	68
3.1.1.1.2	Finnish	70
3.1.1.2	Pseudo-Resultative Predicate is an AP	71
3.1.1.3	The Relation between Adjective and Adverb Morphology	72
3.1.2	Syntax of the Resulting Constituent: Against the Resultative Hypothesis	75
3.1.2.1	The Morphology of Pseudo-Resultatives vs. Resultatives	78
3.1.2.1.1	Finnish	78
3.1.2.1.2	Norwegian	83
3.1.2.2	Cross-linguistic Availability of Pseudo-Resultatives . .	86
3.1.2.3	Particles	87
3.1.2.3.1	Methods	93
3.1.2.3.1.1	Participants	93
3.1.2.3.1.2	Materials	93
3.1.2.3.1.3	Procedure	98
3.1.2.3.2	Results	98
3.1.2.3.3	Discussion	101
3.1.3	Section Summary	102
3.2	Root-Derived vs. Noun-Derived Verbs	102
3.2.1	Nouns vs. Roots	103
3.2.2	Implicit Creation Verbs and Semantic Effects of Categorization . .	104
3.2.3	Implicit Creation Verbs and Irregular Verbal Morphology	107
3.3	Summary	108
4	The vP Structure of Implicit Creation Verbs	110
4.1	Implicit Creation Verbs vs. Inchoative Verbs	112

4.2	Implicit Creation Verbs vs. Explicit Creation Verbs	115
4.3	Implicit Creation Verbs vs. Source-Frame Paraphrases	118
4.3.1	Availability of Passive	119
4.3.2	Unavailability of Low Applicative Arguments	120
4.3.3	Availability of Depictives	124
4.4	Implicit Creation Verbs and Locative Case	125
4.4.1	Finnish Illative Case	125
4.5	Summary	128
5	Japanese Bracketing Paradoxes	129
5.1	Introduction	129
5.2	Japanese Bracketing Paradoxes	130
5.3	Asano's 2004 Proposal	134
5.4	A as a Root Modifier	137
5.5	Extending Asano's 2004 Account	140
5.5.1	Unaccusatives and Passives	140
5.5.2	Status of the Case Marker	144
5.6	Conclusion	145
6	Consequences and Conclusions	146
6.1	The Ontology of Roots	146
6.1.1	Verbs Derived from Predicates of Events	147
6.1.2	Verbs Derived from Predicates of States	151
6.1.3	Summary	153
6.2	The Analysis of Resultatives	154
6.3	The Analysis of Particles	155

6.4 Conclusion	155
Appendix: Experiment Stimuli	157
Bibliography	163

List of Figures

3.1 VPs With vs. Without Resultative Predicates 99

3.2 Pseudo-Resultative vs. Resultative Predicates 100

List of Tables

1.1	Vendler Classes	7
1.2	Generative Semantics Verbal Decompositions	7
2.1	Examples of Root Classes from Harley (2005)	24
3.1	2 (resultative presence) by 3 (particle position) Design	93
3.2	2 (predicate type) by 3 (particle position) Design	96
3.3	Hebrew Templates and Words	106
6.1	Verb Class Patterns	147
6.2	Root Types and Verb Classes	147

Chapter 1

Introduction

One of the central questions of linguistic theory is what the basic building blocks of language are, and how the building blocks of one component of language (e.g., syntax) relate to those of another component (e.g., semantics). One way of asking this question more specifically is to ask whether patterns in certain linguistic expressions can be attributed to common building blocks in one or more components of grammar. For example, one can ask whether the verb *braid_V* in (1a) and the noun *braid_N* in (1b) share a building block at some level of representation, and if so, what the properties of those building blocks are:

- (1) a. She **braided** her hair.
b. She has a **braid** in her hair.

It is typically taken for granted that there is a semantic containment relationship in these pairs, such that the meaning of the verb contains (some of) the meaning of the noun, which can refer (in combination with a determiner) to an entity in the world which contains three strands in a certain configuration. Thus, there might be a semantic building block which is shared between the two words. Due to this assumption, verbs such as *braid_V* have often been described as ‘denominal’, based on two added assumptions - (1) that

words which can refer to entities belong to the syntactic category N, and (2) that the relationship between these words is a derivational one where the verb is derived from the noun. This assumption underlies work such as that of Hale and Keyser (1993), which treats denominal verbs such as *shelve*_V as being syntactically derived from nouns.

- (2) a. She **shelved** the books.
b. The books are on the **shelf**.

However, the intuitive relationship between the meaning of these words does not necessitate that this relationship is grammatically encoded in the form of lexical identity. For example, the kind of semantic relatedness between the nouns *doctor* and *nurse* has been found to be relevant to processing in psycholinguistic priming studies (Meyer and Schvaneveldt 1971). However, there is no evidence that the representations of these words that are relevant to the syntax and semantics are any more related than pairs described as ‘unrelated’ such as *doctor* and *tree*. The question then is whether denominal verbs are related to nouns in a way that is relevant to the syntax and semantics, as opposed to the pair *doctor/nurse*. Ramchand (2006) argues that, for cases like *shelve* at least, they are not. Rather, the relationship is on a par with the relationship between items in the lexicon which share a significant amount of ‘encyclopedic’ information, like *cat* and *dog*. Thus she argues that there is no shared building block between these different forms.

There are several other logical possibilities for the relationship between these words, if we assume a ‘storage’ component, the lexicon (assuming for simplicity that no operations take place in the lexicon) and a computational component which combines elements stored in the lexicon (i.e., syntax):

1. *braid*_V and *braid*_N are primitive lexical items and are related by homophony: Both are listed independently in the lexicon.

2. braid_V and braid_N are both derived and are related by homophony: Neither is listed in the lexicon, nor are they derived from the same lexical element.
3. braid_V is denominal: Braid_N is primitive and listed in the lexicon. Braid_V is derived syntactically.
4. braid_N is deverbal: Braid_V is primitive and listed in the lexicon. Braid_N is derived syntactically.
5. **braid_V and braid_N are both derived from an identical item**: Neither is listed in the lexicon, but they are derived from the same lexical element.

Hypothesis 1 and 2 are compatible with the approach taken by Ramchand. These hypotheses would maintain that the relationship between denominal verbs and the nouns they are intuitively related to is one of homophony, in that there is no shared grammatical identity. In order to explain their related meanings and pronunciations, one would need a theory of phonological identity between lexical items without semantic identity, only relatedness. Hypothesis 3 is the position taken by Hale and Keyser (1993, 2002) and others who propose that denominal verbs are truly denominal, in that they are derived from nouns in some computational component. What may not be obvious is that hypothesis 4 is essentially parallel. That is, there is little evidence for the **syntactic** status of the lexical component as being of the category N. Thus it is just as valid a theory to posit that this element is a V in the lexicon and that the N is derived. However, the last hypothesis, (5), is the one I will adopt here. Lacking evidence for a distinct lexical category of N and V at the subword level, it is really the null hypothesis that the basic building block is not specified for any such category in the lexicon. Rather, if it is possible to derive nouns and verbs in the computation component, which is fairly uncontroversial in the face of the existence of overt derivational morphology, both braid_V and braid_N may be derived from

a root element which lacks either of these category specifications, as proposed in Marantz (1997).

These hypotheses are not only hypotheses of lexical relatedness, but also of lexical complexity. An analysis in the vein of Hale and Keyser (1993) or Marantz (1997) entails that verbs like *shelve* and *braid* would be both syntactically and semantically complex, despite their apparent morphological simplicity. In order for there to be a shared building block between *shelve* and *braid*, one or both must contain that building block plus something more that differentiates them. Ramchand's theory on the other hand does not predict complexity in either component based on this type of relationship. Thus the question is ultimately about the existence of lexical decomposition, and the levels at which it might be grammatically relevant - syntax, semantics or otherwise.

In this dissertation, I do not take the semantic containment relationship between denominal verbs and 'their' verbs for granted; rather, I argue for it. That is, I argue against the view of Ramchand (2006) that apparently denominal verbs bear no relation of lexical identity to the nouns that are intuitively related to. I first argue for lexical decomposition from a semantic perspective. I then argue that a parallel syntactic decomposition makes predictions for the syntax and morphology that are superior to other proposals which would create a mismatch between syntax and semantics, thus providing support for a strongly compositional approach to the syntax/semantics interface.

In independently motivating the syntactic categories and decomposition, I do not adopt Hale and Keyser's (1993) additional assumption, that the identical element is a noun. Rather, I argue that an element of the type of a predicate of individuals must be present in a certain class of 'denominal verbs', implicit creation verbs. An element of this same type is at the root of related nouns as well. However, lacking evidence for features traditionally associated with nouns within the denominal verbs, I follow Marantz

(1997) in arguing that lexical categories like V and N are not primitive, but rather derived by combination of a lexical root element with functional material which has the surface effect of ‘categorization’. Thus contrasts which Hale and Keyser attribute to syntactic category, I attribute to contrasts in root type.

The proposals argued for have consequences for the status of strong compositionality, lexical representation, argument structure, and the analysis of secondary predicates and verb particles. In the rest of this chapter, I will situate the objectives of the dissertation within the current literature and present the central hypotheses and assumptions underlying them.

1.1 Lexical Decomposition in Linguistic Theory

Lexical decomposition is simply the division of words into smaller units at some level of linguistic representation. The extent to which words decompose at various levels has been hotly debated, largely because the properties of the atomic units of any level of grammatical representation are so crucial for the identification of the possible computations that operate on those units. That is, one cannot formulate the conditions for syntactic merge if one does not know what must be merged. Similarly, we cannot identify the operations that are relevant to semantic composition without knowing what the basic semantic building blocks are.

In most linguistic theories, some kind of lexical decomposition is employed. What varies are the level at which the decomposition is relevant, and the types of properties, or features, that are relevant to such decomposition. There are various potential motivations for such decomposition, including data that is phonological, syntactic and semantic. In this section, I will provide a background for some of the various motivations that have

been presented for decomposition at the level of lexical semantics, and for decomposition at the level of syntax. The latter are often assumed to entail the former, though not the other way around.

1.1.1 Semantic Lexical Decomposition

One aspect that is common to most, if not all, lexical semantic approaches is some kind of separation of the lexical ‘root’ material from the more formal properties of the word. This root has gone by various names, including ‘constant’ (Levin and Rappaport-Hovav 1995), but generally refers to the ‘idiosyncratic’ conceptual properties associated with a lexical item. The root is what semantically distinguishes between otherwise grammatically equivalent words such as *cat* and *dog*. The separation of this root element from other categorial properties in the lexical semantics entails some more of lexical decomposition. The semantic decomposition of verbs is often called ‘predicate decomposition’. One approach in this vein was that of Generative Semantics (Lakoff 1968), where words are broken into smaller predicates in order to capture entailment relations between sentences containing semantically-related words. Dowty (1979) and Parsons (1990) make use of predicate decomposition in order to derive generalizations about event structure and aktionsart. Levin and Rappaport-Hovav make use of predicate decomposition to account for patterns in argument alternation and ‘conflation’. These views, although positing different types of semantic decomposition, are not necessarily incompatible with each other. However, they focus on capturing different types of generalizations.

1.1.1.1 Decomposition for Event Structure

Given the division of the root from the ‘functional’ elements that it combines with, one can ask what aspects of the verb’s meaning are not part of the root, yet are components

of the word that are grammatically relevant. This is to ask essentially what the possible inventory of functional elements which combine with roots is. One hypothesis that has been put forward is that the root element combines with predicates which contribute aspectually-relevant material. For example, Dowty (1979) attempts to derive contrasts between Vendler's (1967) classifications of verb phrases (which he ultimately revises) summarized in Table 1.1¹:

Class	Bounded	Continuous	Examples
Stative (State)	-	-	know, believe, have, love
Activity	-	+	run, walk, swim, push a cart
Accomplishment	+	-	paint a picture, push a cart PP
Achievement	+	+	recognize, spot, die, find

Table 1.1: Vendler Classes

Dowty pushes the hypothesis that all verbs are built from states, such that each class is derived from the combination of states and other elements such as DO, BECOME, and CAUSE. Thus states are the primitive building blocks of verbs. For Dowty, states are not framed as eventualities in an event semantics approach, but are properties, or predicates of individuals. The abstract operators that combine with these predicates are syncategorematic elements which map propositions to truth values. A simplified version of Dowty's proposed generative semantics-inspired lexical decomposition is summarized in Table 1.2:

Vendler Class	Composition	Examples
Stative	state	love
Activity	DO + state	walk
Achievement	BECOME + state	cool (intr)
Accomplishment	CAUSE + BECOME + state	cool (tr)

Table 1.2: Generative Semantics Verbal Decompositions

¹The features 'Bounded' and 'Continuous' are as proposed in Verkuyl (1993).

From this system, Dowty derives entailments such as the fact that both the achievement verb ‘cool’ and the accomplishment verb ‘cool’ entail a state of coolness and a change of state. Parsons (1990) continues work in this vein with an event semantics approach to aktionsart.

1.1.1.2 Decomposition for Argument Structure

The functional elements which combine with roots have also been enlisted in the realization of verbal arguments. Different frameworks have developed different ways of representing the argument structure of verbs and then capturing the relation between these structures and the syntax. Baker (1988), Levin and Rappaport-Hovav (1995), and Pustejovsky (1995) propose representations of argument structure which must be mapped to syntax with ‘linking’ rules. Other theories, however, such as those in Hale and Keyser (1993, 2002), and related work, represent the lexical semantics in the syntax directly, thus avoiding the need for linking rules.

If functional elements in the verbal domain make a contribution to both argument structure and event structure, it is possible that there is a separate inventory of elements for each of these jobs, or that the same elements may contribute both the the event structure and the argument structure ‘simultaneously’.

1.1.1.3 Semantic Decomposition and Root Ontology

Given the general agreement on the lexical semantic separation of the root from other lexical properties, the question is to determine what the possible root types are.

As mentioned above, Dowty (1979) proposes that all verbal roots (or simple predicates) are states. He does not discuss how such roots relate to nominal forms.

Kratzer's work motivates the semantic types of roots as they are deemed necessary by the context in which she argues they are found. Thus these types are motivated primarily by combination of roots with higher functional material, and no general predictions of root type are explored. For example, in Kratzer (2000), the German category-neutral root *aufpump*, 'inflate', is given the type $\langle e, \langle s_s, \langle s_e, t \rangle \rangle \rangle$, with a denotation that includes causative semantics. Thus causative meaning would be introduced as part of the lexical content of the root, although in other contexts such meaning is introduced by a functional head.

Levin and Rappaport-Hovav have developed a system in which roots can contribute types such as stuff, state, manner, and instrument. These are not formal semantic types, as their lexical semantics is not tied directly to syntactic composition. The ontology that they propose essentially provides for types similar to formal semantic types, such as 'state', and others which more closely resemble thematic roles. Harley (2005) instead proposes that roots can be things, states, or events. Although such roots may be involved in manner modification, that is not a basic property of any root per se. Rather event-denoting roots can function as manner modifiers when they combine with other event-denoting predicates.

1.1.2 Syntactic Lexical Decomposition

Researchers working on morphology have found that there are connections between the decompositional representations of lexical semanticists and the morphological structure of words. That is, there appear to be subword constituents which correspond to subword meanings posited by semanticists. Further, it has been argued that this morphological structure is represented in the syntax proper. Baker (1988) argues that morphological complexity bears a close resemblance to syntactic complexity, and that the ordering of

morphemes reflects their combination by ‘incorporation’, or head movement. Baker, following Marantz (1981), focuses on morphemes which appear to affect the argument structure of the words that they are part of. Subsequent work such as Kayne (1994) pursues a similar line of reasoning beyond the domain of morphemes which are ‘grammatical function changing’.

The extension of these findings has been to posit that there may be syntactic complexity reflecting semantic decomposition even when there is a lack of overt morphological indication. Hale and Keyser (1993, 2002) take a more radical approach, in proposing that even some apparently simple verbs should be syntactically decomposed. Work on the structure of verbs in the framework of Distributed Morphology (Halle and Marantz 1993) has proposed an even more extreme view - that no verbs or nouns are simple elements. This ties in with the semantic division of the root from other lexical material, as the hypothesis is that root material comes in as an independent syntactic element. Marantz (1997), argues that verbs are not primitive elements, but rather are composed of functional heads in combination with ‘roots’ which contribute lexical meaning. In essence, to be a verb is to be a conflation of a functional verbal element, call it ‘little’ v , with a certain head or heads in the complement of that v .

1.1.2.1 Lexical Decomposition and Lexical Category

As may be clear from the discussion thus far, theories of lexical decomposition are strongly tied to theories of lexical category, as both are theories of lexical representation.

If roots are neutral with respect to the traditional lexical categories such as noun and verb, then the notion of semantic category of the root is even further divorced from lexical category. Lexical category emerges as a consequence of syntactic derivation and the presence of functional material. The roots themselves then may be of any syntactic category

which can combine with these functional elements, and any semantic type which is able to compose with them.

If roots are not specified for lexical category, what governs their possible category realization? If there is no syntactic difference between various roots, then syntax cannot govern their categorial realization. Rather, it falls to the semantics to constrain the possibilities. This brings us back again to the question of the ontology of roots, and highlights the importance of this question for deriving generalizations tied to lexical meaning. It is in fact the only way to answer this question. Constraints on semantic composition, on the possibility of certain roots to combine with certain functional elements, will in turn influence the syntactic environment that a root can occur in. Thus the semantic type is of crucial importance in determining syntactic generalizations about verbs (and other categories).

1.1.3 Open Questions in the Literature on Decomposition

In sum, there are many different semantic motivations for lexical decomposition, including those that support the ‘isolation’ of the root. Syntactic theories of decomposition often make use of these semantic arguments informally in determining the building blocks relevant to syntactic decomposition. However, most accounts of syntactic decomposition are not matched with an explicit theory of semantic composition. Further, arguments for semantic and syntactic decomposition are often intermingled. Thus it is often difficult to draw precise predictions in this domain. There is seldom independent evidence provided for the semantic and syntactic properties of the root itself, largely due to the fact that its properties cannot be easily distinguished from those of its syntactic environment. These are often assumed based on analogues with ‘larger’ categories.

In this dissertation, I address these issues by attempting to motivate the semantic and

syntactic decomposition of a particular class of verbs independently. That is, having established arguments for a semantic composition, it is not assumed that the semantic categories map directly on particular syntactic categories; instead the mapping is justified based on evidence from the domain of syntax. Rather than assuming a close mapping between syntax and semantics, as much work in syntactic decomposition does, I present direct arguments from each domain for such a mapping.

1.1.4 Summary of the Dissertation

In the context of the current debates in the literature, the objectives of this dissertation are as follows:

1. Provide novel evidence for the independent syntactic realization of roots.
2. Provide an explicit syntactic and semantic analysis for the involvement of such roots in the decomposition of implicit creation verbs, which provide much insight into composition at the sublexical level.
3. Illustrate the predictions made by the proposed root type contrasts.
4. Propose general methods for isolating root type and thus further developing the ontology of roots which depend upon asymmetries found between root types.
5. Show that the analysis of a broad range of phenomena, from resultatives to verb particles, can be informed by a precise account of lexical decomposition and root ontology.

To this end, the specific hypotheses for which I present evidence are as follows:

1. Implicit creation verbs are semantically derived from elements which denote predicates of individuals.
2. The semantic complexity of implicit creation verbs corresponds to syntactic complexity.
3. The predicate of individuals contained in implicit creation verbs does not bear the lexical category 'N', but is a neutral with respect to lexical category.
4. Roots form their own syntactic category, but can have diverse semantic types.
5. The ontology of roots must allow for at least predicates of individuals, predicates of states, and predicates of events.
6. Some cases of polysemy are due to flexibility in the possible syntactic environments for a given root. That is, the difference between the noun *braid* and the implicit creation verb *braid* is in environment where the root is inserted.
7. Some cases of polysemy are due to the availability of multiple denotations for a single root. For example, it will be argued that the root $\sqrt{\text{braid}}$ can denote both a predicate of individuals and a predicate of events in English, and that this leads to polysemy between implicit and explicit creation readings.

1.2 Assumptions and Framework

The model of grammar that I am assuming is closest to that presented in Marantz (1997) and Arad (2005) in connection with the Distributed Morphology framework (Halle and Marantz 1993). One key component from Marantz (1997) is the 'single engine hypothesis', that there is one computational system which generates both words and larger con-

stituents. In this framework, words are not built in the lexicon, but rather in the same fashion as phrasal constituents, in the syntax. Words are not atomic, but are built from *roots*, which constitute the atomic syntactic terminals providing the ‘lexical’ content. These roots do not bear categories like ‘verb’ or ‘noun’ (see also Pesetsky (1995), Barner and Bale (2002), Barner and Bale (2005), Borer (2005a), Borer (2005b)). Rather, they seem to ‘join’ these syntactic categories when they combine with what are considered to be category-specific heads in the syntax. For example, Marantz (1997) argues that the verb *grow* and the noun *growth* are both derived from the root $\sqrt{\text{grow}}$, and thus the words are formally related, but neither is derived from the other. Such roots are identified by their phonological signature and are semantically related to one conceptual domain. In Hebrew, for example, roots are consonant clusters which cannot be pronounced on their own, but have an associated meaning and pronunciation that is found in all words derived from them (as argued in Arad (2005)). Throughout the dissertation, I use the term ‘verb’ either in the informal, traditional sense of the word, or as a descriptive term for elements which contain a v head.

I add to this framework that the mapping between such syntactic constituents and interpretation is strongly compositional. The strong interpretation of compositionality I will take is one that admits no semantic rules that do not correspond to steps in the syntactic derivation, nor semantic elements that do not correspond to elements in the syntax. In formalizing the semantic proposals, I will assume an extensional typed λ -calculus in which variables of type e range over individuals, type s over eventualities, and type t over truth values. The type s is subdivided into the sorts s_e for events and s_s for states. I further assume that the only available modes of semantic composition are functional application (as defined in Heim and Kratzer (1998)), predicate modification (functional intersection) (as defined in Heim and Kratzer (1998)), and event identification

(Kratzer 1996).

1.3 Structure of the Dissertation

The structure of the dissertation is as follows. In the second chapter, I present arguments for the semantic decomposition of implicit creation verbs and a semantic analysis of what I will call ‘pseudo-resultative’ predicates. In the third chapter, I will show that implicit creation verbs must decompose in the syntax as well, in order to provide a syntactic modification site for the pseudo-resultative predicates. In chapter four I argue for the decomposition of the vP above the root level. In chapter five I present an extension of this analysis of implicit creation verbs to an apparent bracketing paradox in Japanese. Chapter six concludes the dissertation and highlights the consequences of the proposals for the analysis of resultatives, verb particles, and for root ontology.

Chapter 2

The Semantic Role of Individual-Predicate Roots in Verbal Derivation

The goal of this chapter is to motivate the semantic lexical decomposition of verbs into a root and functional material, and to illustrate the semantic properties of these independent semantic building blocks. The focus will be on a particular class of verbs, which I will call implicit creation verbs, as illustrated by *braid* in (3). This class of verbs has not been treated in much detail in previous literature. It is, however, an interesting class because the environments in which the verbs occur provide novel insight into semantic and syntactic decomposition. This in turn provides insight into the ontology of roots, root modification, the functional elements that combine with roots to derive verbs, verbal polysemy, and the analysis of resultative predicates and verb particles.

- (3) The stylist braided her hair.

I argue in this chapter that the implicit creation verbs are derived from roots which denote predicates of individuals and functional elements which relate that root to the direct object and the event denoted by the verb as a whole. I illustrate the predictions that are made by this proposal, and how they are borne out, with respect to interaction with resultative and what I call ‘pseudo-resultative’ predicates.

2.1 Implicit Creation Verbs

One prediction that we can draw from the semantics of a root in combination with the principle of compositionality is that these semantics are present in the final denotation of the verb - that is, if a verb is derived from a predicate of individuals, this will somehow be relevant to the semantics of the verb as a whole. This is particularly relevant for individual-derived verbs, since verbal functional heads are posited to introduce stative or eventive semantics, but not typically individual-related semantics. Thus if such semantics are evident, then these should be derived from the root.

In this section, I will introduce one such class of verbs, called implicit creation verbs by Geuder (2000) and Osswald (2005). Some verbs that I will argue belong to this class are illustrated in (4):

- (4) a. Mary braided her hair.
- b. She tied her shoelaces.
- c. Mary piled the cushions.
- d. She chopped the parsley.
- e. She sliced the bread.

My definition of the class of implicit creation verbs will diverge somewhat from that of

Geuder and Osswald, for reasons that will be explained throughout this chapter. However, the basic intuition is that these verbs entail the creation of an entity, but that entity is not expressed by an argument of the verb, and is thus implicit. This is in contrast with explicit creation verbs, as in (5), which entail the creation of an entity denoted by the direct object¹:

- (5) a. Mary built a house.
b. Mary baked a cake.

These implicit creation verbs do not form a class in Levin's (1993) verb classification. However, I will argue they do form a grammatically relevant class, in that the role of the root and the functional elements it combines with are relevant to determining linguistic contrasts between the semantic and syntactic characteristics of this class of verbs versus other classes.

This class of verbs coincides to a great extent with those classified as 'goal' verbs by Clark and Clark (1979). Clark and Clark classify nouns which are intuitively denominal by relation to paraphrases. The classifications are not intended to have direct theoretical status, but are descriptive. On Clark and Clark's classification, goal verbs are those for which the verb is derived from a nominal where the nominal names something (the *goal*) which the direct object of the verb (the *source*) becomes. This kind of argument structure can also be seen with the verb *make* in a goal-frame context:

¹Some implicit creation verbs are related to verbs with the same pronunciation found in explicit creation contexts:

- (1) She braided a necklace.

However, I will argue in chapters 4 and 6 that these verbs are structurally distinct, but related in root identity.

(6) She made her hair into a braid.

To draw a parallel with such cases, I will use the term ‘theme’ in place of ‘source’ when referring to the direct object of goal verbs.

Make can also take a goal argument as a direct object and the source as an indirect object, in a source-frame context:

(7) She made a braid from her hair.

To distinguish between these different realizations of *make*, I will refer to the former as *make_{goal}* and the latter as *make_{source}*, where the subscript refers to the non-theme argument of the relevant verb frame.

Clark and Clark define the class of goal verbs as follows: “The important characteristic of these verbs is their factivity: the shape, entity, form, or role denoted by the parent noun comes to exist by virtue of the action denoted by the verb” (Clark and Clark 1979:p.774). Thus by definition all of the verbs in this class will involve an individual denotation and an activity that creates it.

Clark and Clark (1979) consider goal verbs to be ‘denominal’, or derived from nouns. I will argue in chapter 3 that these verbs are derived from roots rather than nouns. That is, it is semantic properties of the root, rather than syntactic category, that is linguistically relevant to a verb’s status as ‘denominal’ as this term is commonly used. For the purposes of this chapter, I will use the term ‘root’ without explicitly defending this hypothesis, since this chapter is about the semantic contribution of this element and no direct arguments will be provided regarding the syntactic realization or category for this element. All of the arguments presented in this chapter are in fact independent of the syntactic categorial status of atomic lexical elements.

2.2 Role of the Root

In this section, I show that the lexical root forms an independent semantic building block within the verb, and elucidate the semantic properties of the roots of implicit creation verbs. This informs not only the analysis of the roots themselves, but also the analysis of the functional elements that they are embedded under.

As discussed above, implicit creation verbs as in (8) entail the creation of an entity, but that entity is not expressed by an argument of the verb:

- (8) a. Mary braided her hair.
b. She tied her shoelaces.
c. Mary piled the cushions.
d. She chopped the parsley.
e. She sliced the bread.

I will focus on these examples of implicit creation verbs, but some other verbs which can receive a similar interpretation in English include *powder*, *heap*, *dice*, *cube*, *knot*, *loop*, *coil*, *copy*, *pickle*, *strand*, *spin*, and *stack*.

The lexical root of a verb is what contributes its ‘idiosyncratic’, or conceptual, meaning. For example, the lexical root is what makes *braid* mean something different than *pile*. In these cases, the difference can be pinned down to a contrast in the type of entity that is created by the event described by the verb. Thus, to ‘braid’ is to create a braid or braids, while to ‘pile’ is to create a pile. This is what is called a ‘goal’ by Clark and Clark (1979).

There are several other classes of ‘denominal’ verbs in English classified by Clark and Clark (1979). The main classes (excluding ‘miscellaneous’ cases) are exemplified in (9):

- (9)
- a. Jane blanketed the bed. (Locatum)
 - b. Kenneth kennelled the dog. (Location)
 - c. Julia summered in Paris. (Duration)
 - d. John butchered the cow. (Agent)
 - e. John witnessed the accident. (Experiencer)
 - f. Edward powdered the aspirin. (Goal)
 - g. Edward worded the sentence. (Source)
 - h. John bicycled into town. (Instrument)

There are two semantically relevant distinctions at play here. One is the semantic characteristic which brings all of these verbs together into one class of ‘denominal’ verbs. The other is the semantic property that divides them, the ‘role’ of the root in the event. I argue in the rest of this section that the former is based in a shared semantic type between the roots of different denominal verbs (and nouns). In section 2.4 I show how the latter is based in variation in the functional context of the root.

2.2.1 Root Type and Telicity

As discussed above, the classification of verbs as falling into the broad class of denominals by Clark and Clark (1979) is based on the existence of paraphrases with nouns. However, the directionality assumed in calling such verbs ‘denominal’ is far from obvious. Thus, verbs as in (10) are not considered denominals by Clark and Clark, despite the fact that they are also zero-related to nouns:

- (10)
- a. The professor laughed.
 - b. The boy walked to school.

Intuitively, the relevant contrast is that the verbs in (10) as well as their corresponding nouns seem inherently ‘eventive’, while those in (9) seem to basically denote entities, typically associated with nouns. However, this is not a syntactic contrast, but rather a semantic one. If such intuitions are suggestive of anything, it is that the former (9) are derived from elements which denote predicates of individuals, while the latter (10) do not contain predicates of individuals, but are more ‘directly’ predicates of events.

Yet even this claim requires further substantiation from relevant linguistic contrasts. As it stands, if one wanted to argue that *laugh* is in fact derived, while *walk* is not, no clear predictions would be made.

Harley (2005) (a development of Harley (2002)) tries to draw more concrete predictions from the semantic types of roots. She argues that at least some ‘denominal’ verbs are semantically derived from roots which denote ‘things’, or entities. Harley does not formalize this claim. However, we can assume that these are predicates of individuals, and using the variable *e* for entities, or individuals, and *t* for truth values, such roots would be of type $\langle e, t \rangle$. In set theoretic terms, such predicates denote a set of individuals. Semantically this set of individuals shares the property denoted by the noun. She further argues that other verbs, such as those in 11, are derived from roots which denote states:

- (11) a. The archaeologist **opened** the sarcophagus.
b. Sue **cleared** the table.
c. Jill **flattened** the metal.

Harley proposes that these are all change-of-state verbs which contain a state-denoting root. If we use the variable *s* for eventualities (a type including both events and states), subscripting with an *s* for states, such roots would be of type $\langle s_s, t \rangle$. Further, there are verbs which are derived from eventive roots, as in (12):

- (12) a. Sue **danced**.
 b. Sue **hopped**.

Such verbs, if derived from predicates of events, would have roots of type $\langle s_e, t \rangle$, where the subscript e on s is used to represent the subclass of eventualities which are events (rather than states). Thus we have at least the following three-way division:

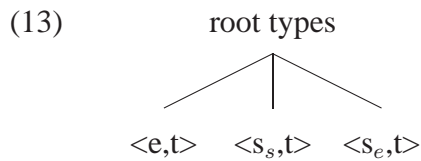

Although Harley calls some of these verbs denominal, the category of noun does not directly play any role. Harley argues for contrasts based on semantic type. The support for the semantic relevance of these contrasts is based in telicity contrasts.

Harley (2005), like Dowty (1979), attempts to derive aktionsart properties of verb phrases from the semantics of verbal roots². Harley argues that the semantic boundedness of such roots as they are used in the nominal domain is also relevant to the telicity of the sentences in which they are in a verbal context. Harley's definition of boundedness is based on that in Jackendoff (1991) and Jackendoff (1996), such that an expression is bounded if no subparts of what is denoted by the expression can be named with the same expression, and unbounded if subparts can be named in the same way³. Thus, since no subparts of an apple can be called *an apple*, *an apple* is bounded. Since some (perhaps all relevant) subparts of water can also be called *water*, *water* is unbounded.

²Harley (2005) does not make an explicit distinction between category-neutral roots and nouns, but generally uses the term 'root' for the lexical component of the verbs.

³Jackendoff's use of boundedness has its foundations in earlier work on the relationship between boundedness and telicity as found in Tenny (1987) and Krifka (1989).

The classification in Harley (2005) is summarized in Table 2.1, along with examples of verbs argued to belong to these classes:

Root Class	Examples
Thing	foal, drool
State	flat, rough, clear
Event	hop, sleep, kick, push

Table 2.1: Examples of Root Classes from Harley (2005)

The central argument is that roots with +bounded semantics give rise to telic verb phrases, while roots with -bounded give rise to atelic verb phrases. This can be seen most clearly in comparing unergative verbs such as *foal* and *drool*. Harley argues that these both have the structure in (14) proposed by Hale and Keyser (1993), such that the root is actually in ‘object’ position, as sister to *v*.

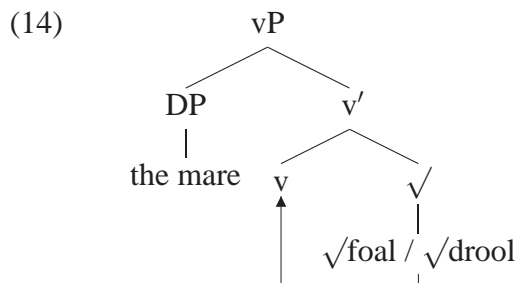

Harley takes this object position to be relevant to determining telicity, thus giving rise to the contrasts in (15) and (16).

(15) a. The mare foaled in two hours / # for two hours.

b. The mare bore a foal in two hours / # for two hours.

(16) a. The mare drooled # in two hours / for two hours.

b. The mare made drool # in two hours / for two hours.

Foal is argued to give rise to a telic VP because it is semantically bounded and thus delimits the event in the same way as the object in (15b). *Drool*, on the other hand, is

mass, and thus gives an atelic VP when the root is either part of the verb or part of the object DP.

As for other types of roots, Harley argues that state-denoting roots are bounded if they have a closed scale, as *flat* has an endpoint of ‘completely flat’, and unbounded if open-scale, as *rough* does not have an inherent endpoint of complete roughness. If the state is bounded and its DP argument is also bounded, then the verb phrase will be telic.

Event-denoting roots are bounded if they are point-like, unbounded if they unfold over time. However, Harley argues, following Pustejovsky (1991) and Jackendoff (1991), that neither produce telic verb phrases because events do not occupy space like individuals do. That is, while the notion of ‘bounded’ in reference to individuals gives quantities which can be measured out, bounded events are essentially instantaneous, having no divisible duration. Bounded events will give point-like vP interpretations which are not telic but semelfactive.

Harley (2005) also argues that event-predicate roots fall into two classes - those where the event-predicate is in the complement of *v*, and those which modify *v* via what she calls ‘manner incorporation’. The former includes verbs such as *dance* and *hop* (17), while the latter includes *hammer* and *fit* in the examples in (18):

- (17) a. She danced.
- b. She hopped.
- (18) a. She hammered the metal.
- b. She fit the horse with a saddle.

Harley argues that in the cases in (17), the roots participate in the argument structure in a manner similar to DP arguments, and thus are complements, versus the roots in (18),

which have more in common with adjuncts. However, she does not provide a syntactic account for manner modifiers.

One prediction of this analysis is that a verb phrase which is telic without the addition of some Goal or resultative phrase will be derived from a bounded individual- or state-denoting root. This prediction is difficult to test, however, since Harley does not provide any independent means of assessing the semantic type of a root. This problem is highlighted by the problem of the verb *spit* discussed in Harley (2005). Harley observes that this verb is problematic, because it seems plausibly individual denoting, considering the availability of the noun *spit*. However, the noun has an unbounded (mass) interpretation, while the verb is not atelic, but rather semelfactive. This is contrary to the predictions for verbs derived from individual-denoting roots. Thus Harley concludes that the verb *spit* is after all derived from an event-denoting root. While this may ultimately be the correct analysis, it is clear that intuitions are not sufficient for determining root type. Although Harley's account goes much further than previous accounts in formulating a strong hypothesis about root ontology, it still ultimately relies on vague intuitions in determining root type. Lacking additional correlations, the analysis is limited in its predictive power.

A further limitation of Harley's approach from the current perspective is that it would seem to assume that each root has only one denotation. That is, that all words derived from a particular root will contain the same root denotation. This would mean that the only possible source of verbal polysemy would be when the same kind of root can be inserted in multiple contexts (for example, if event-predicate roots can be 'complements' or 'adjuncts' to v). I argue in chapter 6 that some cases of verbal polysemy can, to the contrary, be correlated with differences in denotation for the same root.

In the next section, I show how implicit creation verbs fit into Harley's framework, and will also present independent evidence from the domain of modification for determining

root type.

2.2.2 Aspectual Impact of the Roots of Implicit Creation Verbs

Harley (2005) argues that roots with +bounded semantics give rise to telic verb phrases, while roots with -bounded semantics give rise to atelic verb phrases. Harley argues for both a semantic and syntactic component to these telicity contrasts. Within this section, I will address the semantic question, by determining the telicity properties of sentences with implicit creation verbs. The syntax of such verbs will be returned to in chapters 4 and 6.

The first step in testing Harley's hypothesis as extended to implicit creation verbs is to determine the boundedness of the root. Harley uses Jackendoff's (1991) criteria for deciding lexical boundedness. On this approach, 'an apple' is bounded because there is no subpart of an apple which can be described as 'an apple', while 'water' is unbounded because subparts of water can be described as 'water'. Harley assumes that the mass/count properties of the noun derived from the verb correspond directly to a boundedness feature of the root itself. However, these criteria are difficult to use in testing for root boundedness, because the tests are modulated by the presence of the determiner. For example, there is no subpart of 'a water' which can be described as 'a water', in the sense of 'a bottle of water'. Similarly, there are subparts of 'apple' which can be described as 'apple'. Thus these tests don't seem to straightforwardly test for some property of the root.

I know of no way of entirely avoiding these problems and directly determining a boundedness property for roots. However, one way of testing that more clearly establishes whether a root *can* be bounded or not is to test whether it can occur with determiners that require mass or count complement nouns. *Much* in English only combines with nouns in a mass interpretation, while *many* occurs with a count interpretation. If a particular noun

can occur as either, then both will be possible. Using these determiners, we see that nouns like *furniture* must be mass, while those like *toothbrush* must be count, and both *apple* and *water* are underdetermined by their roots⁴:

- (19) a. There is too much furniture in this apartment.
b. # There are too many furniture(s) in this apartment.
- (20) a. # There is too much toothbrush(es) in the medicine cabinet.
b. There are too many toothbrushes in the medicine cabinet.
- (21) a. There is too much apple on my plate.
b. There are too many apples on my plate.
- (22) a. There is too much water on the table.
b. There are too many waters on the table.

Similarly, plural marking forces a count reading and thus is compatible with ‘many’, but not ‘much’.

Using these tests, we see that the roots of implicit creation verbs like *braid* and *pile* seem to be count, or bounded, in a nominal environment:

- (23) a. * There is too much braid in her hair.
b. There are too many braids in her hair.
- (24) a. * There is too much pile on the desk.
b. There are too many piles on the desk.

⁴I am setting aside contexts in which mass nouns can be made count by the ‘universal packager’, and count nouns mass via the ‘universal grinder’, on which see Chierchia (1998).

Harley uses modification by a temporal adverbial phrase as a telicity test, which I will replicate here for implicit creation verbs. The implicit creation verbs *braid* and *chop* pattern as follows:

- (25) a. She braided her hair for/?in a minute.
b. She braided all of her hair *for/in a minute.
- (26) a. She chopped the parsley for/?in a minute.
b. She chopped all of the parsley *for/in a minute.

According to these tests, implicit creation verbs with unbounded mass objects like *her hair* and *the parsley* give rise to atelic sentences. With bounded objects, such as those where an amount restriction is added, the resulting sentence is telic. These tests indicate that implicit creation verbs fall into the class of ‘incremental theme’ verbs. For such verbs, the telicity of the sentence they are embedded in depends (in part) on the boundedness of the theme.

If these verbs were like unergative verbs such as *foal*, then Harley would predict that they always occur in telic sentences. However, the evidence above suggests that, if Harley’s account is correct, these roots must either be non-entity roots, or they are entity roots which do not compose with little *v* in the same way as unergative verbs of birthing. The latter is in fact what Harley proposes for incremental theme verbs such as *saddle* (Locatum verbs) and *box* (Location verbs). These show the telicity pattern in (27) and (28) (Harley 2005:exx.40-42):

- (27) a. John saddled the horse #for 5 minutes/in 5 minutes.
b. Sue fit the horse with a saddle #for 5 minutes/in 5 minutes.
c. Sue fit the horse with saddles for an hour/#in an hour.
d. Sue fit the horses with a saddle for an hour/#in an hour.

- (28) a. Sue boxed the computer #for 5 minutes/in 5 minutes.
 b. Sue put the computer in a box #for 5 minutes/in 5 minutes.
 c. Sue put the computer in boxes for 5 minutes/#in 5 minutes.
 d. Sue put computers in a box for 5 minutes/#in 5 minutes.

The pattern that emerges from this data is that the sentence with a Location or Locatum verb with a +bounded root will be telic so long as the theme and indirect object are also bounded. Harley proposes that this is due to the fact that the root does not combine directly with v , and thus the telicity is mediated by these other elements within the complement of the vP . The structure she adopts is that proposed by Hale and Keyser (1993), where the root is related to v via an embedded prepositional phrase:

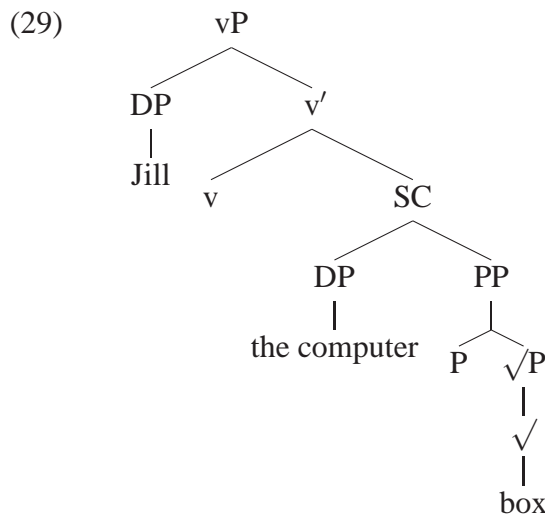

Later in this chapter, I will present additional arguments that the root of the verb is semantically related to the object DP by a relational element somewhat like a preposition. This data is compatible with the semantic component of Harley's generalization, in that the root is embedded in a relational structure and its boundedness properties do not affect

the telicity of the vP. However, I argue in chapter 3 that the semantic composition provides explanation enough for these telicity contrasts, and thus the syntactic component of Harley's analysis is not a necessary conclusion.

In the following sections, it will be shown that this root meaning is relevant to semantic composition beyond aspectual considerations, and thus there is independent evidence that it is realized as an independent semantic building block with a predicate of individuals denotation.

2.3 Relation of Pseudo-Resultative Predicates to the Root

In this section, it will be shown that a certain type of modification provides evidence for the semantic role of individual-predicate roots in the composition of implicit creation verbs. This kind of modification allows us to go beyond intuitions in determining the semantic role and type of verbal roots.

2.3.1 Pseudo-Resultative Modifiers

The sentence-final predicates in both (30) and (31) pertain to the result of an event:

(30) Mary braided her hair **tight**.

(31) Susan hammered the metal **flat**.

However, while resultative predicates such as *flat* in (31) modify the direct object of the verb, the final predicate *tight* in (30) does not. That is, while the metal becomes flat as a result of Susan's hammering it, Mary's hair does not become tight as a result of her braiding it. Rather, what becomes tight is the braid which is created by the braiding.

The sentence-final adjectival predicates in (32) all pattern with *tight* in (30) in that they receive a result-oriented interpretation but do not modify the direct object of the verb:

- (32) a. Mary braided her hair tight.
b. Mary tied her shoelaces tight.
c. Mary piled the cushions high.
d. Mary chopped the parsley fine.
e. Mary sliced the bread thin.
f. Mary ground the coffee beans fine.

The puzzle of what these adjectival modifiers modify has not been addressed in depth in the literature. Such predicates have previously been described as ‘adverbial’ in Washio (1997), Mateu (2000), Kratzer (2005), though such predicates were not the main object of inquiry in any of these studies. Geuder (2000) presents an account for modifiers similar to those in (32) which will be discussed in section 2.3.4. These predicates also do not appear to modify any overt syntactic constituent and have a similar result-oriented interpretation, but they differ from pseudo-resultatives in that they obligatorily occur with the *-ly* morpheme in English. Geuder analyzes these ‘resultative adverbs’ as semantically modifying a resultant individual contributed by the verb. I will show in this section that his semantic analysis, in this rough formulation, can be extended to the adjectival predicates under consideration. However, I will show in section 2.3.4 that the syntax and compositional semantics of these predicates is different from the one that Geuder proposes for resultative adverbs. The availability of pseudo-resultative modification, which is only possible in sentences with implicit creation verbs, is shown to provide crucial insight into this class of verbs.

First I will show that the predicate does not modify an explicit DP argument or the event denoted by the verb phrase.

2.3.2 Not Object DP Modifiers

Since adjectives of the type found in (32) are most standardly considered to be predicates of individuals, one might assume that the pseudo-resultative is a modifier of the individual-denoting object DP. Other cases where secondary predicates are argued to modify the object DPs that they follow are object depictives (33) and canonical resultatives (34):

(33) Object Depictives:

- a. i. Mary hammered the metal_i hot_i. →
- ii. The metal was hot.
- b. i. Mary cooked the meat_i raw_i. →
- ii. The meat was raw.

(34) Resultatives:

- a. i. Mary hammered the metal_i flat_i. →
- ii. The metal is flat.
- b. i. Mary cooked the meat_i black_i. →
- ii. The meat is black.

Pseudo-resultative predicates appear superficially similar to these types of secondary predicates. However, the entailments triggered by such predicates are distinct. The object depictives in (33) modify the direct object such that the property they denote must hold of that object during the event; in (33a-i), the metal must be hot when the hammering event

begins. It is clear that pseudo-resultatives do not contribute depictive-like semantics, as the sentences in (32) do not entail that the state denoted by the adjective holds at the beginning of the event. Their interpretation is rather closer to that of resultatives. Resultatives modify the state of the object at the end of the event, so that (34a-i) entails that the metal is flat at the end of the event, as a result of that event. In considering examples from Romance similar to those in (32), Napoli (1992) proposes they are resultatives. However, as observed by Washio (1997) for similar data, the following entailments do not hold of the sentences in (32), as they would for sentences with resultatives⁵:

- (35) a. Mary braided her hair tight. \nrightarrow Mary's hair is tight.
b. Mary tied her shoelaces tight. \nrightarrow Her shoelaces are tight.
c. Mary piled the cushions high. \nrightarrow The cushions are high.
d. Mary chopped the parsley fine. \nrightarrow The parsley is fine.
e. Mary sliced the bread thin. \nrightarrow The bread is thin.
f. Mary ground the coffee beans fine. \nrightarrow The coffee beans are fine.

In some cases, such as (35e), a resultative reading is possible, but it is truth-conditionally distinct from the pseudo-resultative reading. The resultative reading can be brought out better by substituting 'loaf of bread' for 'bread', as in (36):

- (36) She sliced the loaf of bread thin.

On a resultative reading of (36), so many slices have been made from the loaf that the loaf itself has become thin. There is no entailment with respect to the thinness of the slices. On the pseudo-resultative reading, a thin slice or thin slices of bread have been

⁵Further contrasts between resultatives and pseudo-resultatives will be shown in chapters 3 and 6.

created. The loaf itself could have been a very wide initially, and may remain wide, as ‘thin’ modifies the slices, not the total quantity of bread or loaf.

In the case of both resultatives and depictives, the adjective is straightforwardly interpreted as a predicate of individuals which modifies the noun in the object DP; it is intuitively clear what the world has to be like in order for metal to be hot, or flat. Yet the pseudo-resultative predicates in (32) do not generally share this property. In many cases the adjective is not an appropriate modifier for the relevant entity in any syntactic environment, as shown in (37) ⁶:

- (37) a. ? Her hair was tight. / ? her tight hair
b. ? The cushions were high. / ? the high cushions
c. ? The parsley was fine. / ? the fine parsley
d. ? The bread was thin. / ? the thin bread
e. ? The coffee beans were fine. / ? fine coffee beans

These data show that pseudo-resultatives are not modifiers of the predicate of individuals denoted by the object DP, and thus we must look elsewhere for the argument that they semantically modify. The following entailments hold:

- (38) Pseudo-resultatives:
a. Mary braided her hair tight. → A tight braid was created.
b. Mary tied her shoelaces tight. → A tight knot was created.
c. Mary piled the cushions high. → A high pile was created.
d. Mary chopped the parsley fine. → Fine pieces were created.

⁶Throughout the dissertation, ‘?’ is used to indicate semantic ill-formedness or mild degradedness, ‘%’ for across-speaker variation in judgments, ‘#’ for availability only of an irrelevant reading, and ‘*’ for ungrammaticality.

- e. Mary sliced the bread thin. → A thin slice was created.
- f. Mary ground the coffee beans fine. → Fine coffee grounds were created.

The question that will be answered in this section is how these entailments come about it.

2.3.3 Not Predicates of Events

It was shown in the previous section that the pseudo-resultative does not modify the direct object. Another word that would be in principle available for modification is event denoted by the verb or verb phrase. Pseudo-resultatives have previously been described as ‘adverbial’ (Washio 1997, Mateu 2000, Kratzer 2005). Washio (1997) suggests that these “spurious resultatives”, as he calls them, are adverbial, but does not explore the syntactic and semantic consequences of such an analysis. Kratzer (2005) argues that the only predicates which are truly ‘resultative’ are those found in small clauses with optionally intransitive verbs, and that apparent resultatives found with obligatorily transitive verbs are thus of a different class and “parsed as adverbs”.

These views are in part be motivated by the fact that some predicates with similar semantics are found with *-ly* morphology, along with the assumption that such morphology indicates ‘adverbial’ or ‘adverb’ status⁷ (although only some speakers accept the adverb form in post-verbal position as in (39b)):

(39) Possible Pseudo-Resultatives with Adverb Morphology:

- a. Mary’s hair is **tightly** braided.
- b. % Mary braided her hair **tightly**.

However, the step from *-ly* morphology to predicate of events is not a direct one. It is an empirical semantic question whether these predicates are interpreted as predicates of

⁷This assumption has been challenged elsewhere, recently by Corver (2005).

events, independent of their morphology. In this section, I will address the question of modification from a purely semantic perspective, and argue that pseudo-resultatives are not predicates of events.

In the neo-Davidsonian tradition of event semantics (Davidson 1967, Parsons 1990), both verbs and verb modifiers such as manner adverbs are taken to be predicates of events, such that a phrase as in (40a) would have the semantics in (40b):

- (40) a. run quickly
b. run(e) & quick(e)

The interpretation of both the verb and the manner adverb are as predicates of the same event. Thus, if the event is existentially quantified over, (40b) can be paraphrased as ‘there is a event which consisted of running and was quick’. Among other advantages, this analysis of manner adverbs captures the fact that (41) entails (42):

- (41) The dog ran quickly.
(42) The dog ran.

The same type of entailments do hold for pseudo-resultative predicates, as shown in (43) and (44). However, I will argue that these entailments do not arise in the same way as those found with manner adverbs.

- (43) She braided her hair tight.
(44) She braided her hair.

Geuder (2000) shows that even ‘resultative adverbs’, which always exhibit *-ly* morphology in English, are semantically distinct from manner adverbs and are not simply

predicates of events⁸. For one, we do not want the entailment that the event is beautiful for sentences like (45)⁹:

(45) They decorated the room **beautifully**. → The decorating event was beautiful.

Nor are these entailments appropriate for pseudo-resultatives as in (46):

(46) She braided her hair tight. → The braiding event was tight.

Further, Geuder shows that resultative adverbs are not felicitous with manner paraphrases (47b), in contrast with manner adverbs (48b):

(47) Manner Paraphrase of Resultative Adverb:

⁸Ultimately Geuder does treat these adverbs as compositionally functioning as predicates of events, as will be discussed in section 2.3.4.

⁹Geuder (2000) also considers cases like those in (1), for which he considers *wide* and *tight* to be adverbs, even though they lack adverb morphology.

- (1) a. I opened the door wide.
b. I shut the door tight.

Despite the fact that these predicates are morphologically adjectival, I will not consider these cases here. Note that these are both adjective-derived inchoative verbs, and that these forms of *wide* and *tight* are also possible as modifiers of these adjectives in non-verbal contexts:

- (2) a. The door is (wide) open (wide).
b. The door is (tight) shut (tight).

The examples in (1) may be more similar to true resultatives where the resultative predicate has conflated with *v* as a manner component, being derived from an LF paraphraseable as ‘I opened the door wide open’, parallel to ‘I pushed the door wide open’. Alternatively, these cases may be parallel with pseudo-resultative modification, as proposed in chapter 5 for similar verbs in Japanese. Further work is necessary to tease the two hypotheses apart for these cases.

- a. They decorated the room beautifully.
- b. # They decorated the room in a beautiful manner.

(48) Manner Paraphrase of Manner Adverb:

- a. The police carelessly arrested Fred.
- b. The police arrested Fred in a careless manner.

The same is true of pseudo-resultative adjectives:

(49) Manner Paraphrase of Pseudo-Resultative:

- a. Mary braided her hair tight.
- b. ? Mary braided her hair in a tight manner.

We can conclude from these data that pseudo-resultative predicates are not interpreted as predicates of events. In the next section, I will propose that they are in fact predicates of individuals.

2.3.4 Geuder's Account for Resultative Adverbs

As mentioned above, Geuder (2000) proposes an analysis for the resultative adverbs as in (50):

(50) Resultative Adverbs:

- a. They decorated the room **beautifully**.
- b. She dressed **elegantly**.
- c. They loaded the cart **heavily**.

His analysis is oriented towards accounting for the relation between predicates such as *beautiful* in contexts where they seem to straightforwardly be an 'adjectival' predicate

of individuals, and those where they appear to be an event modifier with adverbial morphology yet are still oriented in some way to an individual. In the case of resultative adverbs, he proposes that, in the compositional semantics, they are predicates of events, but that ultimately they are oriented towards an individual, and thus receive an interpretation like that in other adjectival contexts. The individual that these particular predicates are oriented towards is one that is created as a result of the event. The modification of this resultant individual is the source of their result-oriented interpretation.

On Geuder's account, this individual is not realized directly by any constituent in the syntax, but is accessed as part of the semantic contribution of the verb. Geuder observes that resultative adverbs occur with verbs that have related result nominalizations. He presents this as evidence that these verbs contribute a result that is semantically accessible for modification:

- (51) a. They decorated the room beautifully. ▷ beautiful decoration
b. She dressed elegantly. ▷ elegant dress
c. They loaded the cart heavily. ▷ heavy load
d. She wrapped the gift nicely. ▷ nice wrapping

Geuder calls all such verbs 'implicit creation verbs', because he argues that they all make salient a created individual which is not explicit in the argument structure of the verb. What is important for Geuder is that such verbs provide a salient function for the Predicate Transfer (Nunberg 1995) operation that he argues underlies the interpretation of resultative adverbs. This extra-syntactic rule maps the event denoted by the verb to a pragmatically salient individual, which is the individual then picked up for modification. The operation of Predicate Transfer is defined by Nunberg as in (52), with the condition in (53):

(52) $\lambda P \lambda y [\exists x_{domh}: h(x)=y \ \& \ P(x)]$

(53) Condition on predicate transfer (Nunberg 1995:112): Let P and P' be sets of properties that are related by a salient transfer function $g_t: P \rightarrow P'$. Then if F is a predicate that denotes a property $P \in P$, there is also a predicate F' , spelt like F , that denotes the property P' , where $P' = g_t(P)$

The function ‘ h ’ in (52) is to be specified pragmatically. Geuder suggests that in the case of implicit creation verbs like *load*, this function is supplied by a part-whole relation between the created individual (y) and the meaning of the verb as a whole (x).

Thus to account for the meaning of *heavily* in (54), we apply the Predicate Transfer operation, which gives (55). If this element combines with the verb which denotes a predicate of events, then the result would be (56). The individual which is asserted to exist and is an argument of the function ‘ h ’ is the load created by the event, which according to Geuder, is made pragmatically salient by a part-whole relation between a load and an event of loading:

(54) She loaded the cart heavily.

(55) $\lambda e [\exists x_{domh}: h(x)=e \ \& \ heavy(x)]$

(56) $\lambda e [loading(e) \ \& \ theme(e,the \ cart) \ \& \ \exists x_{domh}: h(x)=e \ \& \ heavy(x)]$

Any verb, or even context, which makes pragmatically salient an individual which stands in a part-whole relation to an event should thus license a resultative adverb. In the next section, I will show that this class of implicit creation verbs, as defined by the availability of result nominalizations, does not form a homogenous class, and only a subset of this class license pseudo-resultative predicates. I propose a different means of defining a compositionally relevant class of implicit creation verbs. In chapter 3, I will further show

that the more restricted class of implicit creation verbs which I define can be syntactically decomposed, and that the created individual is in fact syntactically accessible for modification.

2.3.5 Redefining Implicit Creation Verbs

Geuder (2000) includes in his classification of implicit creation verbs those such as *decorate* and *dress*, as these seem to license resultative adverbs. However, it seems that these do not belong in a homogenous class with verbs like *braid* in English, since the latter allows for adjectival pseudo-resultative modification, while the former do not, as shown in (57). That is, a smaller class of verbs licenses pseudo-resultative predicates, which exhibit adjectival morphology.

- (57) a. * They decorated the room beautiful.
b. * She dressed elegant.
c. * They loaded the cart heavy.
d. * She wrapped the gift nice.

Semantically, such verbs can be ruled out from the class because they do not have the same creation entailments as the verbs which license pseudo-resultatives, and they further do not require a ‘theme’ argument. To decorate does not entail the creation of any ‘decorations’ per se; rather one can add items to the scene without creating anything new. In the same way, the verb *dress* does not entail the creation of any new entities, only involves arrangement of articles of clothing. These contrasts may seem vague, since one can envision dressing as creating an outfit. However, another important contrast between these verbs and the class I am defining as implicit creation verbs is that the direct object is not a ‘source’ in the terms of Clark and Clark (1979). For both verbs, the direct object

is an affected object. So, *dress* might fit into the class of implicit creation verbs if the articles of clothing that are made into an outfit were realized in the direct object position, as in *She dressed the new clothes*. However this is clearly not the canonical interpretation of *dress*. Similarly, *decorate* as an implicit creation verb would occur in sentences such as *She decorated the string lights*, where the lights are made into decorations.

The class of implicit creation verbs which license pseudo-resultative modification coincides to a great extent with the class of verbs classified as ‘goal’ verbs by Clark and Clark (1979). There is some flexibility in the notion of ‘theme’ and the nature of the activity that brings about the creation. In the case of *braid*, the theme, such as hair, is arranged in order to create a braid. The same holds for *pile*. Verbs like *slice*, however, involve destruction of the theme, such as a loaf of bread, in order to create entities such as slices which consist of part of the original theme. This contrast does not seem to be relevant to the licensing of pseudo-resultative predicates, at least not in English.

2.3.6 Proposal: Root Modification

It was shown above that the pseudo-resultative predicate does not semantically modify any ‘word’ in the syntax. Rather, the relevant entailments are those in (58):

(58) Pseudo-resultatives:

- a. Mary braided her hair tight. → A tight braid was created.
- b. Mary tied her shoelaces tight. → A tight ‘tying’ was created.
- c. Mary piled the cushions high. → A high pile was created.
- d. Mary chopped the parsley fine. → Fine ‘pieces’ were created.
- e. Mary sliced the bread thin. → A thin slice was created.
- f. Mary ground the coffee beans fine. → Fine coffee grounds were created.

In contrast with resultatives, the resultative-like semantics found with pseudo-resultatives are contributed not by the addition of or modification of a resultant state, but by modification of an individual which is created as a result of the event.

As discussed above, Geuder (2000) proposes a pragmatic account for these entailments. However, in this section, I will show how pseudo-resultative predicates are able to compositionally modify such ‘created individuals’. I will argue that the pseudo-resultative predicate modifies the individual or individuals brought about by the event denoted by the verb.

In the derivation proposed, the pseudo-resultative adjective combines with the root before the root itself combines with any other element which might ‘freeze’ its interpretation. At this point, all denotations of the root are accessible for the composition of the adjective and the root¹⁰.

I assume that the pseudo-resultative, being an adjectival predicate of individuals, is of type $\langle e, t \rangle$, mapping individuals to truth values. Although adjectives are sometimes given types as predicates of states (such as $\langle e, \langle s, t \rangle \rangle$), as will be discussed further in section 2.4.2, there is no clear evidence for such a state argument within this constituent. In order for this predicate to combine with the root, the root must either be of type e , for combination by function application, or of type $\langle e, t \rangle$, for composition by predicate modification.

I propose that the root is of type $\langle e, t \rangle$, rather than type e . If the root were type e , it would denote an individual, which is not the desired interpretation for such a verbal root; the meaning contributed to the verb *braid* by the root $\sqrt{\text{braid}}$ is not the denotation of a particular individual, but the denotation of the set of braids, such that the entity created as a result of the event is a member of that set. The root cannot be of type $\langle \langle e, t \rangle, \langle e, t \rangle \rangle$,

¹⁰See chapter 6 for more details on the multiple interpretations provided by roots.

taking the pseudo-resultative predicate as an argument, because the pseudo-resultative predicate is not obligatory. The composition is represented in (59):

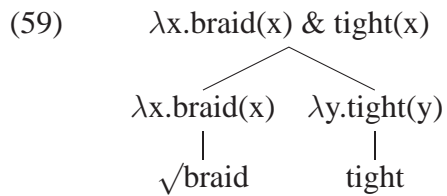

The resulting constituent will be of the same type as the root alone, $\langle e,t \rangle$, and thus the semantic composition can continue in the same manner as when the pseudo-resultative is not present.

Since at a later point in the derivation the root will be embedded within a verbal environment, it must be compatible with a categorizing v head higher in the structure. That is, the denotation that is selected by the adjective must also be a denotation that is compatible with the particular v . The denotation of the root accessed by the adjective is also consistent with the denotation of the root in the verbal structure, as illustrated in 2.5.

2.4 Relation of the Root to the Object DP

In the previous section, it was argued that the roots of implicit creation verbs denote predicates of events. One might then ask how such roots semantically compose with the apparent ‘direct objects’ of the verbs they derive. Assuming that the DP denotes an individual, of type e , one possibility for composition with the root, of type $\langle e,t \rangle$, would be via function application, as in (60):

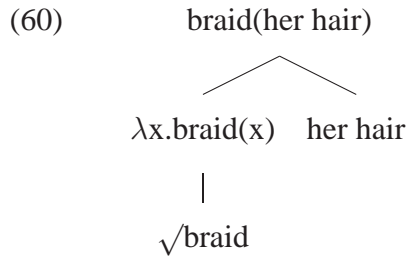

The result of this composition would be a proposition that ‘her hair’ is a braid. This is not the desired result, as the entailment of the implicit creation verb *braid* is not that the hair is a braid, but rather that the hair is **in** a braid. Another option which could capture the appropriate entailments is to relate the two elements via one or more additional relational elements, such that they do not compose with each other directly. This is the proposal that I will argue for in this section. The alternative that I propose is that the root is related to the direct object via a functional element which functions semantically somewhat like a preposition, in a similar vein to proposals made in Hale and Keyser (1993, 2002). This brings us back to the proposal of Harley (2005) that incremental theme verbs derived from bounded thing-denoting roots must not be derived from direct combination of the root with the direct object.

The semantic relation between the root of implicit creation verbs and the object DP is one of ‘goal’ and ‘theme’. In sentences like (61), the creation, a braid, is made out of hair, the theme:

(61) The stylist braided her hair.

This relation is similar to the one introduced by the preposition *into* in sentences such as (62):

(62) The stylist made her hair **into** a braid.

In this case, the complement of the preposition *into*, *a braid*, is the goal, while the specifier of the preposition, *her hair*, is the theme. The semantic parallelism between these

sentences to be defended in this section is represented in the trees in (63). The preposition *into* in (63a) is broken down into the prepositions *in* and *to*, for reasons to be discussed in the next section. The covert parallels to these that are present within implicit creation verbs are labelled IN and TO, with capital letters signifying the non-pronunciation of these elements in this context:

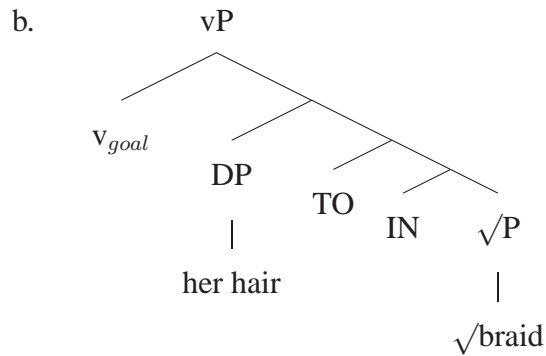
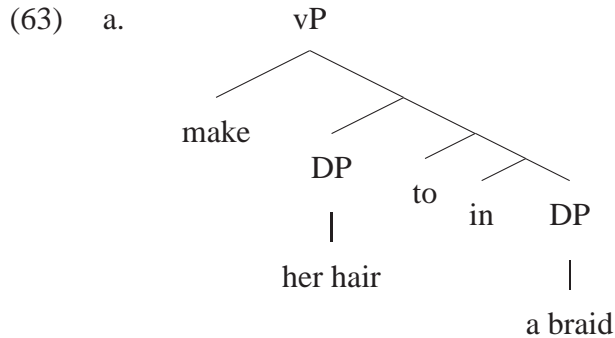

I will argue that, despite surface syntactic differences, the semantic structures underlying both types of sentence are very similar to each other. The essence of the proposal is that implicit creation verbs differ semantically from sentences like (62) only in the argument type of the localizer elements, *in* and IN, and the denotation of the eventive heads, *make* vs. *v_{goal}*. The syntactic ramifications for this semantic analysis will be addressed in chapter 3.

2.4.1 Locative Semantics

For the time being, I treat preposition *in* as a simple locative element which relates the two DPs by establishing one (the theme) as the constituting material of the other (the goal). This is a special kind of location - it is ultimately not enough that the hair is located in a braid. However, I propose that this difference is not due to the element relating the two DPs, but rather to the verb that occurs with that element, which I return to in the next section. So, in (64), *into* is purely locative because it occurs with a purely locative verb. However, the relation between the DPs in (65) is one where the goal is constituted by the theme, because the verb is not a purely locative verb.

(64) She put the wool into the cabinet.

(65) She made the wool into a scarf.

Being the material that constitutes the goal, the theme is necessarily in the same location as well. In the terminology of Kracht (2002), *in* specifies the configuration component of the relation between the DPs, called a localizer. *In* can be seen to be used independently in this way in the following examples:

(66) Her hair is **in** a braid.

(67) The pillows are **in** a pile.

(68) The bread is **in** slices.

(69) The vase is **in** pieces.

I propose that a null element with similar semantics is present in implicit creation verbs. This element, which I will call IN, differs from *in* in pronunciation and in the syntactic and semantic category of its complement. However, the relation between the

arguments of each preposition is the same. *In* is analyzed as being of type $\langle e, \langle e, t \rangle \rangle$, taking two individual, type e arguments, as represented in the denotation in (70):

$$(70) \quad \llbracket \text{in} \rrbracket = \lambda x. \lambda y. y \text{ is in } x$$

IN, on the other hand, does not combine first with an individual, but rather a predicate of individuals. This predicate of individuals is the root of the verb.

$$(71) \quad \llbracket \text{IN} \rrbracket = \lambda f_{\langle e, t \rangle}. \lambda y_e. \exists x_e. f(x) \ \& \ y \text{ is in } x$$

I assume that this kind of relationship between null and overt prepositions is a general one, as would also be found in the relationship between the overt preposition *onto* and the null prepositional head(s) which have been proposed for the decomposition of locative verbs like *shelve* in work such as Hale and Keyser (1993). The TO element would be the same in both cases, whereas IN and ON would differ from each other only in locative semantics, not argument structure.

According to Kracht (2002), in addition to the configuration component, there is also a ‘mode’ component to locatives, called the modalizer. The mode specifies how the ‘mover’ moves with respect to the configuration. If the mover is in the configuration at the beginning of the event, the mode is ‘co-initial’, if it enters the configuration at the end of the event, the mode is ‘cofinal’. If the mover does not change in configuration during the event, then the mode is ‘static’. There are also ‘transitory’ and ‘approximative’ modes which are not relevant to the discussion here.

To specifies a cofinal mode; although the hair does not start out being in a braid, at the end of the event, the braid and the hair share a location, and are thus cofinal. Examples of *to* used cofinally in English are given in (72):

$$(72) \quad \text{a.} \quad \text{She ran } \mathbf{to} \text{ the store.}$$

- b. The water changed from hot **to** cold

Unlike *in*, however, the contribution of *to* seems to be dependent on the verb. That is, while *to* always co-occurs with events that are ‘dynamic’ in the sense of Kracht (2002), such that the mover undergoes a change of location, or state, this dynamic component may be contributed by the verb, rather than the modalizer itself. While it is difficult to determine which of these elements contributes the dynamic semantics, and which is merely ‘agreeing’, there is syntactic motivation for analyzing the locative element as agreement, and the verb as contributing the dynamic event. In languages with case marking such as German, the modalizer is often realized as a case marker in addition to a preposition, which serves as the localizer. Chomsky (1995) analyzes case as agreement; case is the realization of agreement with a c-commanding probe. On such a treatment, if the case is determined by the verb, the verb would be the probe and the locative element the goal. Therefore I treat the modalizer as a form of agreement with the element which contributes the event, rather than an element which introduces such semantics itself, even if in English it is realized as part of a complex preposition, rather than as a case marker within the DP. More specifically, I assume that overt and null *to*/*TO* are type-theoretically inert elements. Their ‘semantic’ contribution is really syntactic, in the form of features which must be checked. Their representation in the semantic composition is motivated by their overt realization in some environments. The syntactic motivations for positing such elements in the cases where they are null will be presented in the next chapter.

The preliminary proposal for relational semantics introduced by *IN* (and *TO*) and the composition of the sentence in (73) is given in (74). This analysis will be further refined in the next section.

- (73) She braided her hair.

- (74) a. $\llbracket \text{IN} \rrbracket = \lambda f_{\langle e,t \rangle} . \lambda y_e . \exists x_e . f(x) \ \& \ y \text{ is in } x$
 b. $\llbracket \text{TO} \rrbracket =$ type-theoretically vacuous (agreement with causation introduced by v)
 c. $\exists x_e . \text{braid}(x) \ \& \ \text{her hair is in } x$

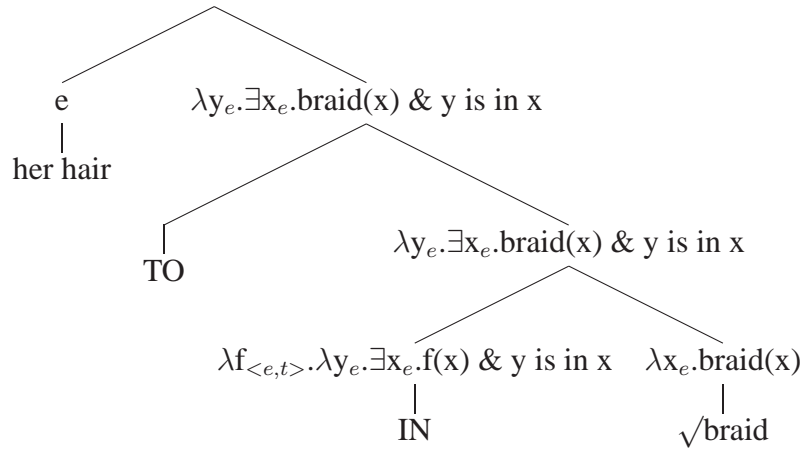

The analysis of sentences with the overt counterparts to *in* and *to* would proceed as in (75):

- (75) a. She made her hair into a braid.
 b. $\llbracket \text{in} \rrbracket = \lambda x . \lambda y . y \text{ is in } x$
 c. $\llbracket \text{to} \rrbracket =$ type-theoretically vacuous (agreement with causation introduced by v)
 d. her hair is in a braid

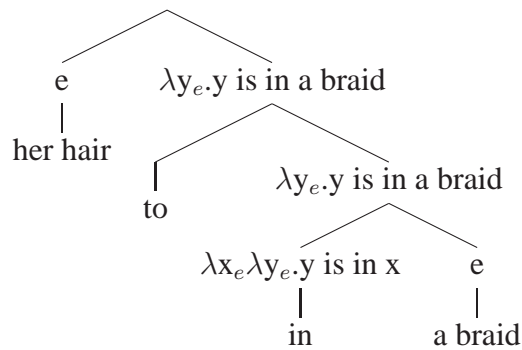

2.4.2 Adding a State

The analysis presented above gives a locative relation between the root and the object of the verb. The constituent that combines with the eventive v head, as illustrated in the next section, would be a proposition, of type t . However, there are several arguments that this constituent is not of type t , but also has a stative eventuality argument, and is at least of type $\langle s,t \rangle$. These arguments will be presented in this section.

2.4.2.1 Semantics of Locative PPs

One argument for the presence of a state within the relational small clause is due to the presence in that small clause of a locative PP, which elsewhere is treated as a predicate of an eventuality. Locative PPs often receive an ‘adverbial’, or adjunct, analysis, when realized in environments such as in (76):

- (76) a. She played hockey in the park.
b. She won the game in an hour.

These adverbial uses are semantically treated as predicates of events, like manner adverbs. One motivation for this analysis is the preservation of entailments between sentences illustrated in (77):

- (77) a. She played hockey in the park. \rightarrow She played hocked.
b. She won the game in an hour. \rightarrow She won the game.

Kracht (2002) argues independently for the presence of an eventuality argument within locative PPs, as a necessity for accounting for the locative semantics itself.

2.4.2.2 Semantics of *re-* Prefixation

Further evidence for the presence of an eventuality argument within the relational small clause of implicit creation verbs is the availability of restitutive readings with the prefix *re-*. Implicit creation verbs can be prefixed with *re-*, as in (78):

- (78) a. She re-braided her hair.
b. She re-chopped the parsley.
c. She re-piled the pillows.

The restitutive reading of *re-* is parallel with restitutive readings found with *again*, as contrasted with repetitive readings. Sentences such as (79) are ambiguous between these two distinct readings of *again*, paraphrased in (80):

- (79) Sue opened the door again.
- (80) a. Sue did something again, and as a result the door opened. (Repetitive)
b. Sue did something, and as a result the door returned to its previous state of being open (Restitutive).

For the repetitive reading, *again* introduces a presupposition that the agent has previously been the agent of an event of opening the door. In this case, *again* semantically has scope over the *v* head in order to scope over the event. For the restitutive reading, the presupposition is that the door has been open before. This reading will be felicitous as long as the door was open previously, whether or not it was opened by the same agent, or in fact whether it ever changed state to becoming open before. The following is a context where the restitutive reading, but not the repetitive reading, would be felicitous:

- (81) A construction worker, Bill, working on a new house has installed a door frame for the front door, and then attached a door in the open position. He then closes

it for the first time to make sure it fits properly. While Bill is checking the door, John comes up from the other side and opens it again.

Since the door has never undergone an event of opening before, *again* could not have a repetitive interpretation, but only a restitutive interpretation. It can be seen by the preservation of the entailments contributed by *again* under negation that the contribution is actually one of presupposition:

- (82) a. Sue opened the door again. (repetitive) → Sue had previously opened the door.
b. Sue didn't open the door again. (repetitive) → Sue had previously opened the door.
- (83) a. Sue opened the door again. (restitutive) → The door had previously been open.
b. Sue didn't open the door again. (restitutive) → The door had previously been open.

According to von Stechow (1996), *again* has the same denotation for both readings, but the different interpretations arise from differences in scope. This scope analysis is based on the fact that the readings available with the German equivalent of *again*, *wieder*, depend on its position. This contrast is illustrated in (84) (von Stechow 1996: ex.1-1):

- (84) a. Ali Baba Sesam wieder öffnete. (restitutive/repetitive)
Subj Obj again opened
b. Ali Baba wieder Sesam öffnete. (only repetitive)
Subj again Obj opened

Von Stechow argues that *again* is possible in both of the positions in (85), where the higher position corresponds to the repetitive reading, and the lower to the restitutive reading:

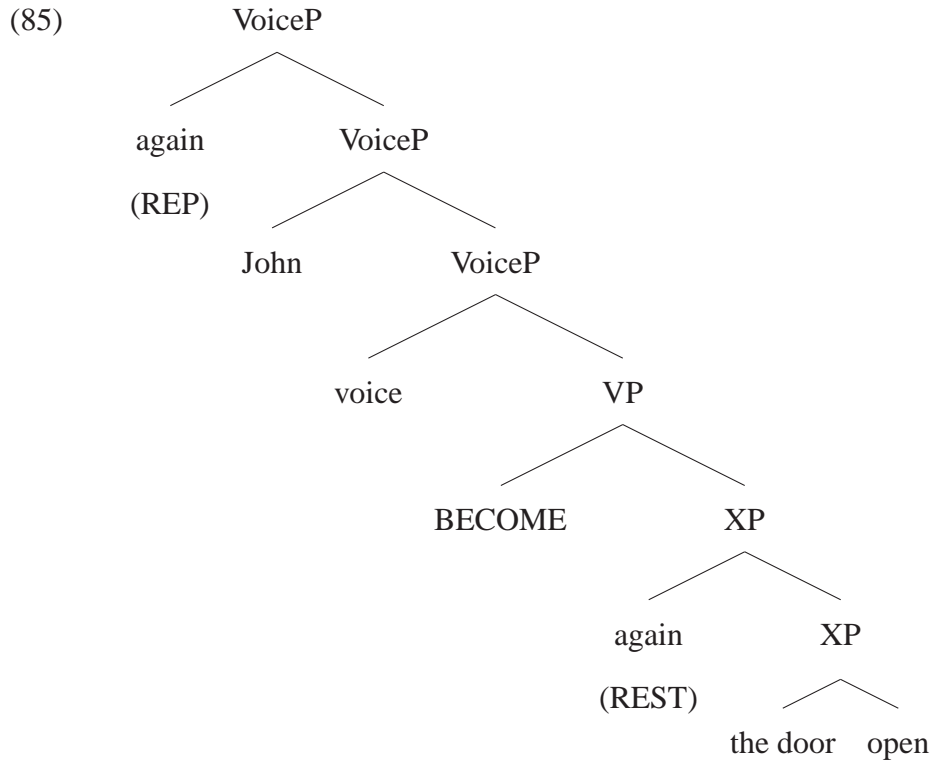

This structure involves lexical decomposition of the verb similar in spirit to the proposals in Dowty (1979). Beck and Johnson (2004) present the formalization in (86) for the denotation of *again*, based on von Stechow’s proposal (I have used the type ‘s’ for events, rather than their type ‘i’, for consistency with this work):

$$\begin{aligned}
 (86) \quad & \llbracket \text{again} \rrbracket (P \langle s, t \rangle)(e) = 1 \text{ iff } P(e) \ \& \ \exists e' [e' < e \ \& \ P(e')] \\
 & = 0 \text{ iff } \sim P(e) \ \& \ \exists e' [e' < e \ \& \ P(e')] \\
 & \text{undefined otherwise}
 \end{aligned}$$

According to this analysis, *again* takes as an argument a predicate of events. What will vary depending on scope is what predicate of events it will take as an argument. For the repetitive reading, *again* semantically scopes over the main event argument, while for the repetitive reading, it scopes below it. The argument in the case of the repetitive reading

must be the predicate of events, or more specifically, predicate of states, that is a sub-event of the verb.

Marantz (2007) extends Stechow's (1996) account of *again* to the prefix *re-*, arguing that *re-* is semantically parallel with *again*, but only gives rise to a restitutive reading. Marantz illustrates this by showing that *re-*, in contrast with *again*, is incompatible with pure activity verbs (87) (Marantz 2007:exx.11a-b), which would follow if *re-* required a state that is not present in such verbs:

- (87) a. * John re-smiled.
b. John smiled again.

The availability of restitutive readings is shown with examples such as (88):

- (88) The door of the cabinet was built open, and John closed it for the first time when he brought it home. Mary then re-opened the door.

In order to give rise to a restitutive interpretation, the prefix *re-* must scope over a constituent which contributes a state argument, but cannot scope over the main event of the sentence. This means that availability of the prefix *re-* indicates the presence of a constituent denoting a predicate of states. This is precisely what is found with implicit creation verbs.

It is difficult to create a natural context that definitively shows that the *re-* in *re-braid* is purely restitutive. However, another implicit creation verb, *slice*, can be used to construct the following test context, suggested by Alec Marantz (p.c.):

- (89) The cheese slices were made by pouring the cheese into plastic molds. Mary stacked 5 slices of cheese to use for making sandwiches, but they melted together. So Mary **re-sliced** the cheese to make lunch.

The form *re-slice* is felicitous in this context, where only a restitutive reading would be possible. Since the cheese in this context has never been sliced before, no repetitive reading would be possible. Thus the availability of restitutive readings with implicit creation verbs prefixed by *re-* is confirmed, and therefore the presence of a state is also confirmed.

In light of the conclusions above regarding the availability of a state for restitutive modification with implicit creation verbs, it is surprising that such verbs do not seem to give rise to restitutive readings with *again*. That is, it does not seem that the sentence in (90a) is felicitous in the context given in (89) above.

(90) a. She sliced the cheese again. (?? restitutive)

This is surprising for several reasons. One is that the relevant state should be available for modification, since it is available for modification by *re-*. Further, it seems that this state is at least marginally available for modification in the parallel sentences with *make_{goal}*, as in (91):

(91) She made the cheese into slices again. (? restitutive)

This could be because the semantics between the implicit creation verbs and *make_{goal}* are not in fact parallel. However, there is also another possible route for explanation which is compatible with the proposal given here. One key to the solution is the contrast between the available readings of *again* with implicit creation verbs, as in (90a), and with inchoative verbs, as in (92):

(92) She opened the door again. (restitutive)

Inchoative verbs license restitutive readings, while implicit creation verbs do not. A potential locus for this contrast is in the additional structure necessary to mediate the relationship between the root of the implicit creation verb and its direct object, versus the

direct combination of the root of an inchoative verb with its direct object, as discussed further in chapter 6. It seems that *again* is able to modify a small clause headed by a root (92), or a phrase headed by an overt, state-introducing preposition (91), but not one headed by a semantically similar covert element which is ultimately incorporated into the verb. It may be that *again* cannot intervene between the IN and TO heads. *Re-* does not have such a problem modifying elements which incorporate to form the verb, and thus is able to modify the state embedded in the implicit creation verb¹¹.

2.4.2.3 Compositionally Adding the State

The sections above supported the presence of a state argument within the constituent that is a complement of *v* for implicit creation verbs and *make_{goal}*. It was argued that such states are also present in PPs headed by localizers alone. Thus I propose that the denotations of *in* and IN be modified as in (93):

- (93) a. $\llbracket \text{in} \rrbracket = \lambda x. \lambda y. \lambda s_s. \text{being-in}(s)(x) \ \& \ \text{theme}(s,y)$
 b. $\llbracket \text{IN} \rrbracket = \lambda f_{\langle e,t \rangle}. \lambda y_e. \lambda s_s. \exists x_e. f(x) \ \& \ \text{being-in}(s)(x) \ \& \ \text{theme}(s,y)$

Modifying the composition of the small clauses which these elements head gives the derivations in (94) and (95):

¹¹A further contrast between implicit creation verbs and *make_{goal}* is that *re-* is ungrammatical with *make_{goal}*:

- (1) * She re-made the cheese into slices.

Keyser and Roeper (1992) argue that *re-* is blocked in such cases due to competition for the ‘abstract clitic’ position, here occupied by the directional preposition. Marantz (2007) argues that *re-* is generally incompatible with small clause verb complements. The latter approach, at least formulated this generally, is incompatible with the analysis presented here for implicit creation verbs.

- (94) a. She made her hair into a braid.
 b. $\llbracket \text{in} \rrbracket = \lambda x. \lambda y. \lambda s_s. \text{being-in}(s)(x) \ \& \ \text{theme}(s,y)$
 c. $\llbracket \text{to} \rrbracket =$ type-theoretically vacuous (agreement with causation introduced by ν)

d. $\lambda s_s. \text{being-in-a-braid}(s) \ \& \ \text{theme}(s, \text{her hair})$

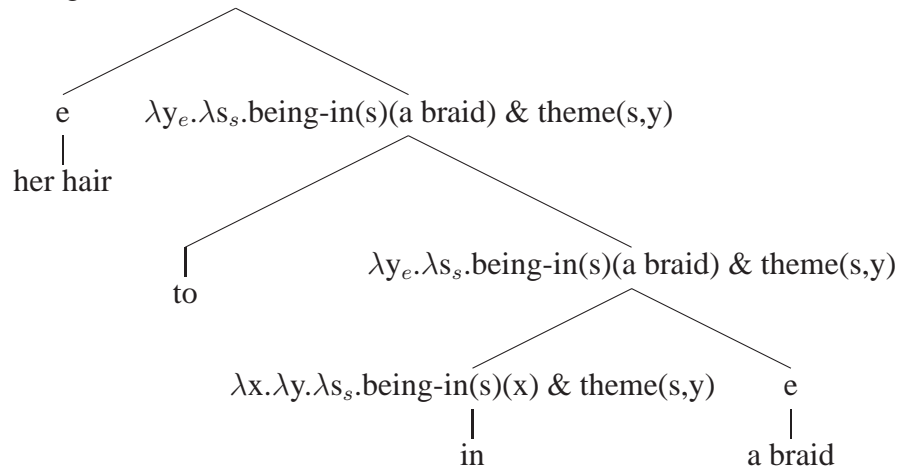

- (95) a. She braided her hair.
 b. $\llbracket \text{IN} \rrbracket = \lambda f_{\langle e,t \rangle}. \lambda y_e. \lambda s_s. \exists x_e. f(x) \ \& \ \text{being-in}(s)(x) \ \& \ \text{theme}(s,y)$
 c. $\llbracket \text{TO} \rrbracket =$ type-theoretically vacuous (agreement with causation introduced by ν)

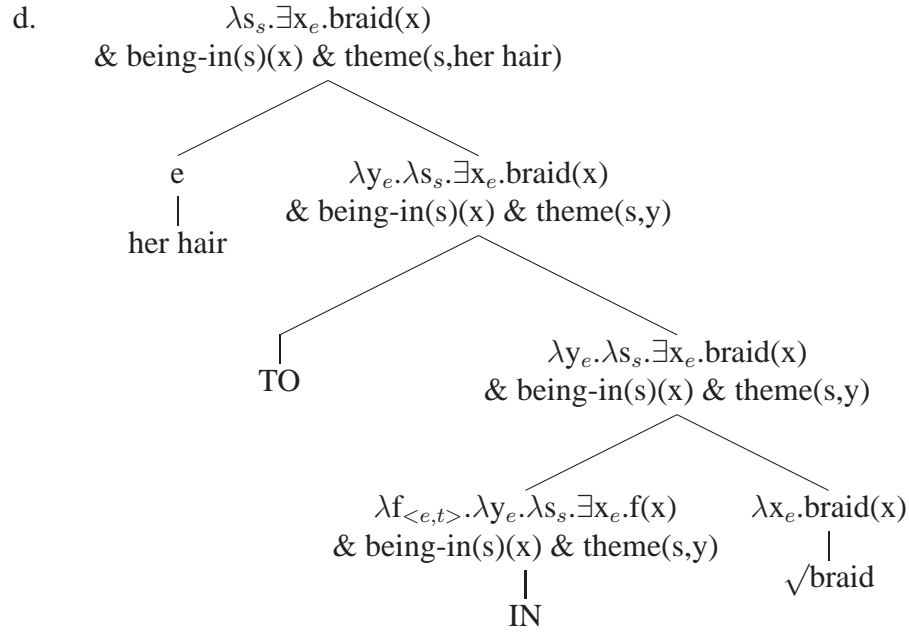

If *re-* is merged in a position higher than the merge of IN, it will be able to access the state argument introduced by that head and modify the appropriate argument for a restitutive interpretation¹².

¹²The precise position of *re-* in this structure and the details of the composition remain to be determined, both for implicit creation verbs and for the verbs discussed by Marantz (2007). There are several open questions regarding the scope of the prefix and the interpretation of the DP arguments and modifiers such as pseudo-resultative predicates. For example, both resultative and pseudo-resultative predicates seem able to fall outside the scope of *re-*, despite other indications that these elements should be within the modified constituent:

- (1) a. She re-braided her hair tight. (presupposition: her hair was previously in a braid)
 b. She re-painted the wall white. (presupposition: the wall was previously painted)

Marantz (2007) suggests that this is an indication that such modifiers are in fact ‘adverbial’ and syntactically outside the scope of *re-*. However, it has been argued in great detail here that at least pseudo-resultative predicates bear a close relationship to the root, and thus another solution to this puzzle must be found.

2.5 Relation of the Root to the Event

The composition of the root with a relational functional element and the direct object DP results in a phrase which is a predicate of states¹³. However, implicit creation verbs are eventive. This eventiveness arises from the combination of the previously detailed building blocks with a verbal or *v* head. The relational small clause containing the root of the verb and the direct object will thus be related to the main event of the sentence. It will be seen in the next chapter that at least some such verbs exhibit causative morphology in languages that have it, such as Finnish. However, there is more than causative semantics introduced by the verb, as the complement of the verb is locative, yet the meaning of the verb is not purely locative, as was discussed above. Rather, the eventive head bears additional meaning, such as that found with *make_{goal}*. Although in some contexts the verb *make* seems like a purely causative verb, as in (96), as *make_{goal}*, with a relational small clause complement including a theme/goal relation, there is always an entailment of creation (97).

(96) a. She made the waiter wipe the table.

(97) a. She made the wood into a table.

Thus for implicit creation verbs, the *v* is a ‘light’ creation verb which contains causative semantics. The state introduced by the small clause is brought into being by an event of creation. The denotation for *v_{goal}* is in (98):

¹³Specifically, the constituent resulting from the combination of the root and the IN head will be of type $\langle e, \langle s, t \rangle \rangle$. This is the same type that will be proposed for the roots of inchoative verbs in chapter 6. However, this constituent cannot occur in the same environments as roots which are of the same type. This must be due to syntactic constraints, since the category of the constituent containing IN and a root will be a PP, while that containing only a root will be a \sqrt{P} .

(98) $\llbracket v_{goal} \rrbracket = \lambda f_{\langle s,t \rangle} \lambda e. \exists e'. f(e') \& \text{CAUSE}(e')(e)$

(99) a. She braided her hair.

b. $\llbracket v_{goal} \rrbracket = \lambda f_{\langle s,t \rangle} \lambda e_s. \exists s_s. f(s) \& \text{creation}(e) \& \text{CAUSE}(s)(e)$

c. $\llbracket \text{IN} \rrbracket = \lambda f_{\langle e,t \rangle} \lambda y_e. \lambda s_s. \exists x_e. f(x) \& \text{being-in}(s)(x) \& \text{theme}(s,y)$

d. $\llbracket \text{TO} \rrbracket = \text{type-theoretically vacuous (agreement with causation introduced by } v)$

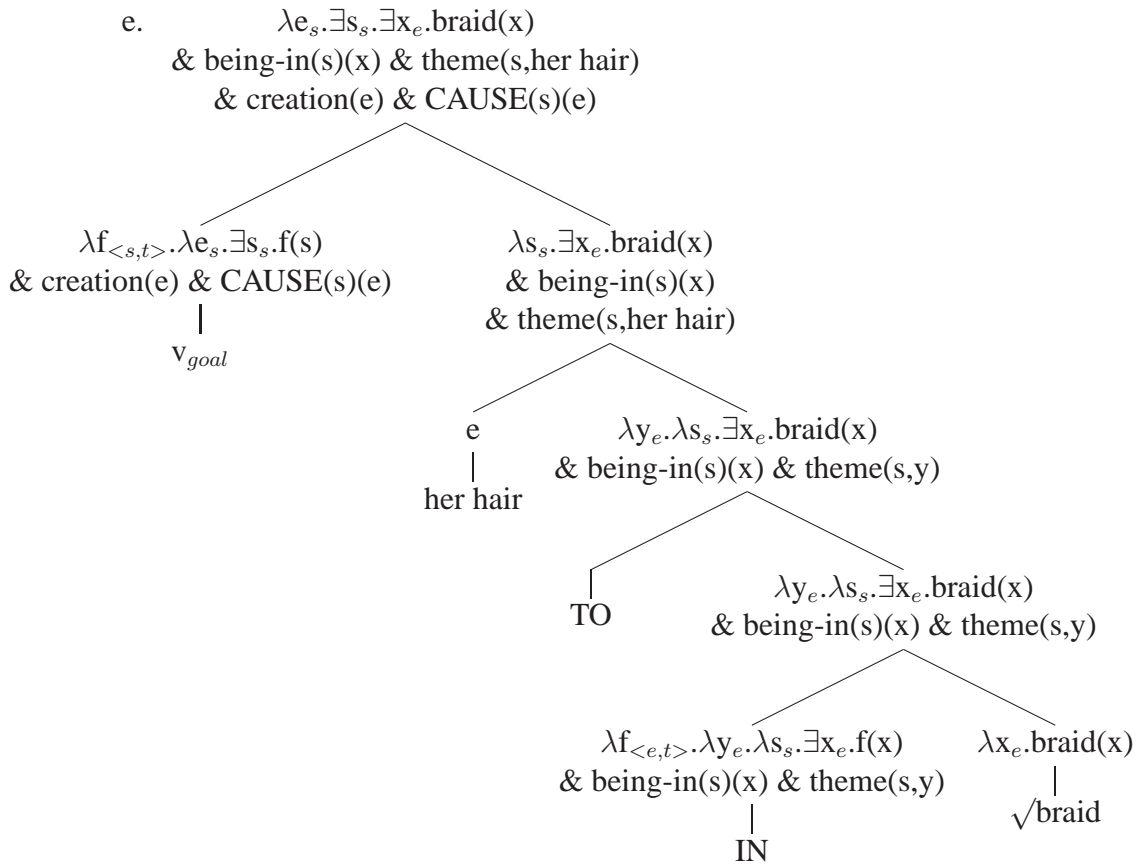

The parallel sentence with make_{goal} would be derived with the verb make_{goal} instead of v_{goal} , as in (100e). The empirical difference between these two verbs other than their pronunciation is found in the fact that not all implicit creation verbs can be paraphrased with the overt verb *make*. This is due to the fact that in addition to requiring an event of

creation, the overt verb *make* requires a stricter type of relation between the theme and the goal. There does not seem to be one lexical verb in English that corresponds to all of the contexts of v_{goal} . I represent this difference in the composition simply as a difference between the predicate $creation(e)$ for v_{goal} and $making(e)$ for $make_{goal}$.

- (100) a. She made her hair into a braid.
 b. $\llbracket make_{goal} \rrbracket = \lambda f_{\langle s,t \rangle} . \lambda e_s . \exists s_s . f(s) \ \& \ making(e) \ \& \ CAUSE(s)(e)$
 c. $\llbracket in \rrbracket = \lambda x . \lambda y . \lambda s_s . being-in(s)(x) \ \& \ theme(s,y)$
 d. $\llbracket to \rrbracket =$ type-theoretically vacuous (agreement with causation introduced by v)

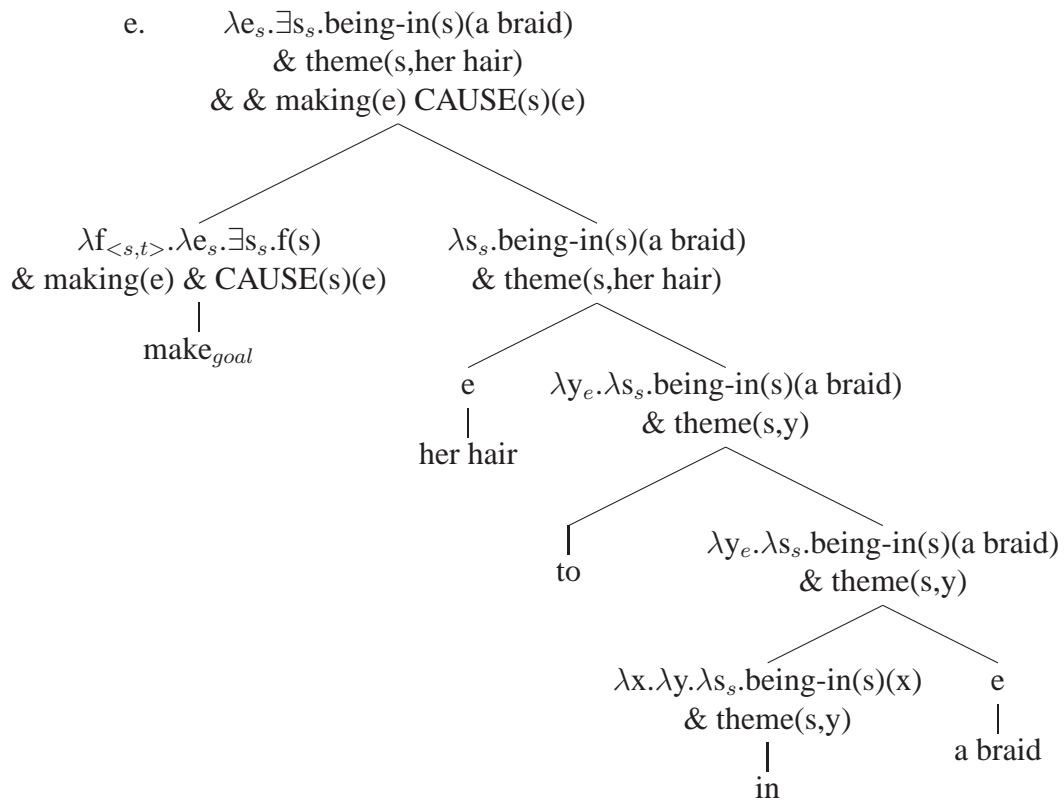

I follow Pylkkänen (2002) in positing that the agent is introduced by an independent semantic building block, called *voice*. Pylkkänen (2002) argues that causative *v* heads in English are always ‘bundled’ with the *voice* head, in that no causative *v* occurs without the introduction of a *voice* head:

$$(101) \quad \llbracket \text{voice} \rrbracket = \lambda x. \lambda e. \text{agent}(e, x)$$

The composition of *voice* with the previous constituent would proceed as in (102) for implicit creation verbs:

$$(102) \quad \begin{array}{c} \lambda x_e. \lambda e_s. \exists s_s. \exists x_e. \text{braid}(x) \\ \& \text{being-in}(s)(x) \& \text{theme}(s, \text{her hair}) \\ \& \text{creation}(e) \& \text{CAUSE}(s)(e) \& \text{agent}(e, x) \\ \swarrow \quad \searrow \\ \lambda x_e. \lambda e_s. \text{agent}(e, x) \quad \lambda e_s. \exists s_s. \exists x_e. \text{braid}(x) \\ | \quad \& \text{being-in}(s)(x) \& \text{theme}(s, \text{her hair}) \\ \text{voice} \quad \& \text{creation}(e) \& \text{CAUSE}(s)(e) \end{array}$$

The subject which will be merged above *voice* is the agent of the causing event, as in Pylkkänen (2002).

2.6 Summary

In this chapter, it was shown that implicit creation verbs are semantically complex in a way that is grammatically relevant, since such complexity is necessary to explain the semantic role of pseudo-resultative predicates. It was further argued that the lexical roots of such verbs are predicates of individuals, and are related to the direct object of the verb via relational heads which make locative and stative contributions to the composition. These arguments are independent of purely intuitive notions of the semantics of such roots, and thus provide methods for evaluating predictions based on root types.

Chapter 3

The Syntax of Roots and Root Modification

In the previous chapter, it was argued that pseudo-resultative predicates semantically modify the root of implicit creation verbs. In this chapter, I will argue that this modification is reflected by modification in the syntax. This is in contrast to syntactic analyses of the pseudo-resultative as either (a) a VP-adjunct adverb (Geuder 2000, Kratzer 2005) or (b) as a resultative predicate (Napoli 1992). It will be shown that these analyses are empirically inadequate for the data presented, and the structure in (103) will be defended instead.

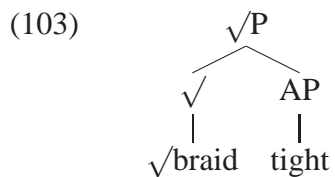

In the first section I will specifically defend the view that the pseudo-resultative predicate is an AP that is merged with the root in a \sqrt{P} . In the second section I will specifically

address the analysis of the root as a category distinct from the traditional lexical category of noun, despite the similar semantics between these.

As the structure proposed reflects the semantic structure detailed in the previous chapter, in contrast with other syntactic analyses which would involve a syntax-semantics mismatch, this analysis provides support for the possibility of a strongly compositional model of the syntax-semantics interface.

3.1 Syntax of Root Modification

The composition of the pseudo-resultative predicate and the root of the implicit creation verb was analyzed in chapter 2 as predicate modification, with the root and the modifier combining directly as in (104).

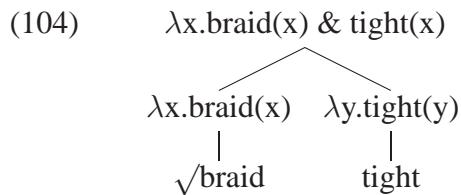

The crucial claim regarding the composition of the root with the pseudo-resultative predicate is that these combine before the merge of the eventive head. However, the syntactic structure of this constituent is underdetermined by the semantics.

In this section, I will argue for the categories and structure in (105):

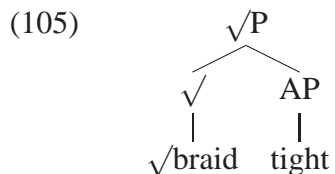

I will argue that the pseudo-resultative predicate as it is realized in English is of the category AP, and that the syntactic evidence points towards a modification structure like that found in English post-nominal DP-internal modification. I will show with evidence from pseudo-resultative modification across languages that the pseudo-resultative predicate enters the vP in a different structure than manner adverbs and resultative predicates, supporting syntactically the semantic contrasts made with these categories in chapter 2. Later, in chapter 5, I will then present an account for a type of modification found in Japanese which is semantically similar to pseudo-resultative modification, but differs in the category of the modifier, and show that in this case the modifier is an A head, rather than an AP.

3.1.1 Category of the Pseudo-Resultative Predicate: Against the Adverb Hypothesis

It has previously been argued in the literature that predicates here described as pseudo-resultatives are ‘adverbial’, such that these are implicitly or explicitly analyzed as VP-adjuncts (Washio 1997, Mateu 2000, Kratzer 2005). Such arguments have been made in large part to distinguish pseudo-resultatives from resultatives. While the distinction between these two types of predicates is valid, the correct analysis for pseudo-resultatives is not adverbial. In this section I will argue that pseudo-resultative predicates pattern syntactically with adjective phrases in English and other languages such as Finnish and Norwegian. This will provide syntactic support for the semantic claim in the previous chapter that pseudo-resultative predicates pattern with adjectival, rather than adverbial, modification.

I will also show later in chapter 5 that semantically similar predicates sometimes occur as adjectival heads in compounds, rather than as phrases, e.g. in Japanese. This shows

that the category of the modifier is not per se crucial to the interpretation, as long as there is modification of the root.

3.1.1.1 Pseudo-Resultative Predicate is Adjectival

As discussed in chapter 2, predicates which are semantically similar to pseudo-resultatives sometimes occur with *-ly* morphology in English:

- (106) a. Mary's hair is **tightly** braided.
b. % Mary braided her hair **tightly**.

However, there is cross-linguistic morphological evidence for the status of pseudo-resultatives as adjectives; they bear morphology not found on verb modifiers like adverbs. Although for English one might claim that the adverb morphology is 'droppable', in languages such as Catalan and Finnish, pseudo-resultative predicates bear distinctly adjectival morphology.

3.1.1.1.1 Catalan Mateu (2000) observes that pseudo-resultatives like those in (107) from Catalan, which he calls spurious resultatives following Washio (1997), exhibit obligatory adjectival agreement on the predicate:

- (107) a. M' he lligat els cordons de les sabates (ben) estrets.
Me-dat have-1st tied the laces of the shoes (very) tight-PL
'I tied the laces of my shoes very tight.'
b. Talla-les menudes.
cut-them fine-PL
'Cut them fine (i.e., into fine pieces).'

In these examples, the pseudo-resultative predicates bear plural marking, which is a mark of agreement with the direct object. This kind of adjectival agreement is often called

‘concord’. Such agreement occurs in Catalan on both attributive and predicate adjectives, as seen in the examples from Wheeler et al. (1999:77) in (108):

- (108) a. la meva estimada muller
 the-F my-F dear-F wife-F
 ‘my dear wife’
- b. Aquelles taronges no s’ón pas madures.
 those-F.PL oranges-F.PL are not ripe-F.PL
 ‘Those oranges are not ripe.’

This agreement is distinct from the adverbial affix *-ment* found on adjective-derived adverbs, which do not show agreement with any DP in the sentence, illustrated with data from Wheeler et al. (1999:222) in (109):

- (109) a. lliure ‘free’ → lliurement ‘freely’
- b. automàtic ‘automatic’ → automàticament ‘automatically’

The agreement found with Catalan pseudo-resultatives is one case which highlights the syntactic, versus semantic, nature of such agreement. This is because the predicate agrees with the object DP, although that DP is not the subject of the predicate. That is, *estrets*, ‘tight’ in (107a) agrees with the object *els cordons de les sabates*, ‘shoelaces’, although it is not the shoelaces that are tight at the end of the event, but rather the tying of the shoelaces. This syntactic agreement can be represented assuming that the adjective enters the derivation with uninterpretable ϕ -features and must check these against an element with interpretable ϕ -features, along the lines of Chomsky (1995). The object DP is the closest element bearing ϕ -features, since roots do not have them (see section 3.2). This agreement relation is represented with an arrow in the tree in (110):

(110)

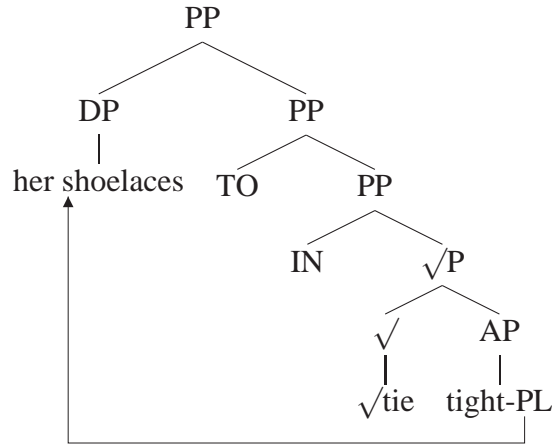

One cannot claim that these predicates with adjective morphology are adverbs with omitted adverbial morphology.

3.1.1.1.2 Finnish A similar argument can be constructed based on Finnish, where adverbs and adjectives bear distinct suffixal morphology of a different kind. Finnish does not have grammatical gender, but adverbs have a *-sti* suffix (111a). As in English, Finnish allows some pseudo-resultative predicates with adverb morphology. However, in the cases without adverb morphology, there is an overt locative, illative case marker as in (111b), to be discussed further in section 3.1.2.1.1:

- (111) a. Mari leti-tt-i hiuksensa tiuka-**sti**.
Mari braid-CAUS-PAST hair-ACC.POSS tight-ADV
'Mari braided her hair tightly.'
- b. Mari leti-tt-i hiuksensa tiukka-**an**.
Mari braid-CAUS-PAST hair-ACC.POSS tight-ILL
'Mari braided her hair tight.'

Locative case markers such as the illative in Finnish are found on nominal and adjectival elements, but not on adverbs. In this case, we see that the pseudo-resultative predicate can be realized with either case marking or adverbial marking in Finnish. This sheds

light on the English option of adverbial and zero-marked predicates, suggesting that the zero-marked predicates may in fact be adjectival, just as the illative-marked variant in Finnish.

The question that then arises is what it means for both options to be possible, and what the relation is between the adjectival and adverbial forms. This will be addressed in section 3.1.1.3.

3.1.1.2 Pseudo-Resultative Predicate is an AP

The pseudo-resultative modifier must be a phrasal constituent in English, since the modifier can be complex:

- (112) a. She braided her hair [_{AP} very tight].
b. She piled the pillows [_{AP} three feet high].

The phrasal status of this constituent also allows for evidence of the availability of number agreement within the constituent in that *feet* is plural in form. This is in contrast with pre-nominal adjectival modification in English, where number agreement is not possible, arguably due to the status of the adjective as a complex head or compound, rather than a phrasal constituent. This contrast between prenominal and postnominal modifiers was observed by Sadler and Arnold (1994):

- (113) a. a three foot/*feet high pile
b. a pile three *foot/feet high
c. The pile was three *foot/feet high.

(114) shows that the pseudo-resultative patterns in the same way as post-nominal, phrasal modifiers¹:

¹I would like to thank Chris Collins for bringing this contrast to my attention.

(114) Mary piled the books three *foot/feet high.

The same is true of resultative and depictive secondary predicates in English²:

(115) She_i entered the school [three *foot/feet tall]_i (and left a foot taller). (Subject Depictive)

(116) They built the tower_i [thirty *story/stories high]_i. (Resultative)

Thus we conclude that this constituent is an AP which patterns with predicative and postnominal APs in English in allowing for agreement. In the following sections, further evidence will be provided for the combination of this AP with the other constituents in the derivation.

3.1.1.3 The Relation between Adjective and Adverb Morphology

It has been seen for both English and Finnish that predicates that are semantically similar to pseudo-resultative predicates are found with both adjectival and adverbial morphology. One possibility which has been proposed in the literature, that these are syntactically the

²These APs do not seem to be interchangeable with relative clauses, as none of the secondary predicate APs can be replaced by relative clauses while maintaining their interpretations:

- (1) a. She piled the pillows which were three feet high. (no result interpretation)
- b. She entered the school which was three feet tall. (no subject-oriented reading)
- c. They built the tower which was thirty stories high. (no result interpretation)

These sentences are grammatical, but do not have the intended interpretations parallel to the secondary predicate APs. The only secondary predicate which seems paraphraseable with a relative clause is an object depictive. However, this does not seem to be anything more than a paraphrase, since the semantic restrictions imposed by the object depictive are not upheld with the relative clause. Result readings may not be available due to the tense in the relative clause which conflicts with a result reading dependent on the main event.

same but one results from dropping of adverb morphology, was discounted in the previous section. Instead it was argued that pseudo-resultative predicates are adjectival.

In Finnish, we see that there is distinct marking for the adverb and adjective forms, and yet both are possible in some cases. However, the two are not interchangeable. That is, there are environments where only one or the other is possible.

This can be seen also in English with the cases in (117):

- (117) a. She piled the cushions high.
b. * She piled the cushions highly.
c. * the highly piled cushions

The adverb form *highly* does not seem possible with a resultative adverb interpretation. This is not due to a lack of a form *highly*, since this form occurs as an intensifier in examples like those in (118):

- (118) a. She was a highly esteemed author.
b. It is highly unlikely that he will arrive on time.

Conversely, many of the examples that Geuder discusses, such as those in (119), are not possible without adverb morphology in English:

- (119) a. * They decorated the room beautiful.
b. * She dressed elegant.
c. * They loaded the cart heavy.

Thus while there seems to be a relation between pseudo-resultative predicates and ‘resultative adverbs’, these are not the same modulo a simple ‘surface’ morphological difference.

I have argued in chapter 2 that the cases discussed by Geuder which do not occur with adjectival morphology are distinct from pseudo-resultatives. While they have a similar result-oriented interpretation, the verbs they occur with are not implicit creation verbs and thus the relation between the root and the predicate is different.

As for the cases where both adjectival and adverbial morphology is possible, I propose that this ‘alternation’ is syntactically dependent. That is, the form with adverb morphology is syntactically distinct from a root-modification structure, at least in final form. So, the proposal is that *tight* in (120a) and *tightly* in (120b) differ in syntactic position:

- (120) a. Mary braided her hair tight.
b. % Mary braided her hair tightly.

Geuder (2000) also argues that adverb morphology is syntactically dependent, and does not indicate the semantic type or argument structure of the adverb. Morphology like English *-ly* behaves more like inflectional morphology than derivational morphology, as argued recently in Corver (2005) (who cites the earlier works of Emonds (1985, p.201 fn.9) and Sugioka and Lehr (1983)). The impact of the effect of syntactic position on the acceptability of adverb morphology for some speakers shown in (120) above supports such a view. For such speakers, adverb morphology on the relevant class of predicates is acceptable on the predicate before a participle, but not acceptable when following the same verb in finite form. What is crucial is that, while, cross-linguistically, predicates with adjectival morphology do not modify verbs, there is no implication in the other direction, that predicates with adverb morphology necessarily *do* modify verbs. The presence of adverb morphology indicates a syntactic difference between such predicates and pseudo-resultatives, but precisely what that difference is will not be explored here and is left for future work.

The possibility of the realization of the pseudo-resultative in a position which licenses adverb morphology seems related to the availability of an adjectival passive of the relevant verb. Thus, in cases where adverb morphology is not possible, the adjectival passive is also not possible:

- (121) a. * Mary saw the piled pillows.
b. Mary piled the pillows high(*-ly).
- (122) a. * Mary saw the opened door.
b. Mary opened the door wide(*-ly).

This fact is reminiscent of the fact that some speakers only accept the adverb morphology on pseudo-resultatives as modifiers of participles as in (123):

- (123) Mary's hair is tightly braided.

Although I do not have a detailed account for this pattern, the data point to the treatment of these apparent 'adverbs' as being semantically parallel to pseudo-resultatives, but having a distinct surface syntactic position which results in adverb rather than adjective morphology.

3.1.2 Syntax of the Resulting Constituent: Against the Resultative Hypothesis

In the previous sections evidence was presented that the pseudo-resultative in English is an adjectival phrase. There are several possibilities for how this AP could combine with the root or verb. It has previously been proposed that predicates which have been argued here to be pseudo-resultatives have the structure of resultatives. Two prominent traditions in the syntactic analysis of resultatives are the 'small clause' analysis (Kayne

1985, Hoekstra 1988, Kratzer 2005) and the ‘complex predicate’ analysis (Marantz 1989, Larson 1991, Carrier and Randall 1992, Neeleman 1994). In the small clause analysis given by Kratzer (2005), the resultative predicate is the predicate of a small clause which the ‘object’ DP is a subject of, as in (124). The causative head relates the small clause to the event introduced by the verb.

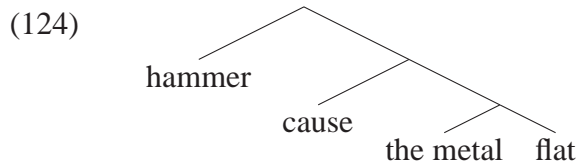

If pseudo-resultatives were like small-clause resultatives, the structure would be like that in (125), a small-clause analysis of resultatives from Kratzer (2005):

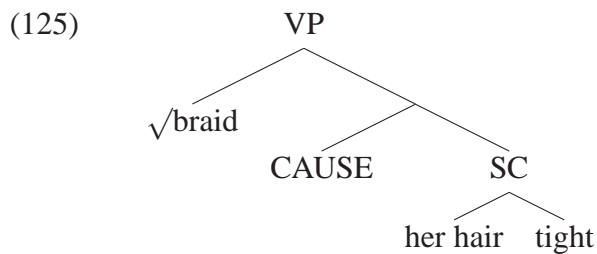

In the complex predicate analysis as presented in Neeleman (1994), the verb mediates a predication relation between the object DP and the adjectival predicate.

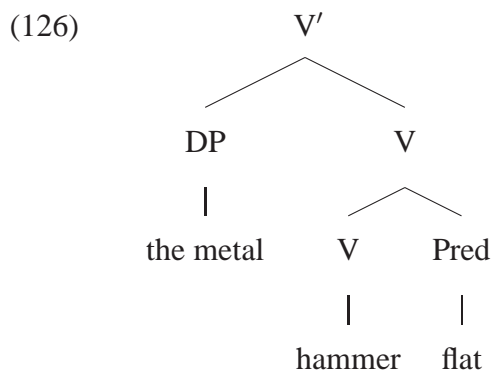

The structure in (127) is what the pseudo-resultative predicate would look like on Neeleman's (1994) analysis of resultatives:

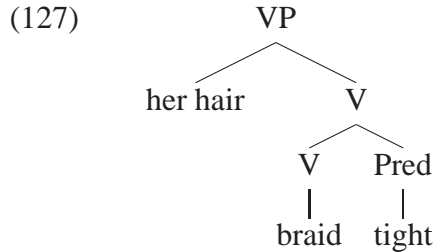

In the previous chapter, however, it was argued that pseudo-resultatives are semantically distinct from resultatives, and here it will be shown that there is syntactic motivation for this contrast as well. Pseudo-resultative predicates do not combine as in the resultative structures above, but rather by combination of an AP with the root of the verb. This AP is embedded in a \sqrt{P} , headed by the root of the implicit creation verb. Although the lexical elements which combine in a complex predicate analysis resemble this combination, in such an analysis the element which combines with the AP is a V, rather than a root. Further, the root must be the head of the modification structure, such that the syntactic category of the root is not affected by the addition of the adjective. That is, this modification more closely resembles DP-internal adjectival predication, where the addition of an adjective does not affect the syntactic category of the larger DP, than a predication structure such as a small clause. If there were some type of small clause, then the head of that small clause would be of a different category than the root itself and would not be selected by the same head, IN, which selects the root $\sqrt{\text{braided}}$.

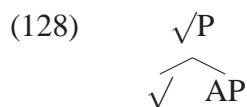

This difference in structure predicts syntactic differences between pseudo-resultatives and resultatives, not just semantic ones. In the following sections it will be shown how this prediction is borne out.

3.1.2.1 The Morphology of Pseudo-Resultatives vs. Resultatives

The syntactic differences proposed between resultatives and pseudo-resultatives presented above predict morphological and syntactic differences between the two types of predicates within a language. The morphological differences cannot be seen in English, since there is no case or agreement marking on adjectives. However, it can be seen in other languages such as Finnish and Norwegian that this is borne out.

3.1.2.1.1 Finnish In Finnish, adjectival and nominal elements bear case morphology. These case markers functionally seem to express similar relations as prepositions in languages such as English, such as a locative relation. Resultative predicates of different types in Finnish are all marked with translative case, as in (129):

(129) Finnish:

- a. Mari joi teekannu-n tyhjä-ksi.
Mari drank teapot-ACC empty-TRANSL
'Mari drank the teapot empty.'
- b. Mari hakkasi metalli-n litteä-ksi.
Mari.NOM hammered-ACC metal-ACC flat-TRANS
'Mari hammered the metal flat.'
- c. Mari nauroi itsensä käheä-ksi.
Mari laughed herself hoarse-TRANS
'Mari laughed herself hoarse.'
- d. Joki jäättyi kiinteä-ksi.
river froze solid-TRANS

‘The river froze solid.’

- e. Tuuli jäädy-tti joe-n kiinteä-ksi.
wind freeze-CAUS river-ACC solid-TRANS
‘The wind froze the river solid.’

Translative case is a non-locative case in Finnish. Fong (2001:2-3) describes translative case as occurring with verbs of change of state as in (130), where it marks the outcome of the change, and causative change of state verbs (131), where it marks the result state:

- (130) a. Toini tuli sairaa-ksi.
Toini-NOM become-PST.3S ill-TRANS
‘Toini became ill.’
- b. Hän muuttu-i touka-sta perhose-ksi.
S/he change-PST.3S caterpillar-ELA butterfly-TRANS
‘S/he changed from a caterpillar into a butterfly.’
- (131) a. Taikuri muutt-i perhose-n touka-ksi.
magician-N change-PST.3S butterfly-ACC caterpillar-TRANS
‘The magician changed a/the butterfly into a caterpillar’
- b. Taikuri muutt-i elefanti-n pienemmä-ksi.
magician-N change-PST.3S elephant-ACC small-TRANS
‘The magician made (lit. ‘changed’) a/the elephant small.’

Although the translative case is not strictly locative, in his account for locatives, Kracht (2002) describes the translative as the ‘cofinal’ variant of the ‘static’ essive case. That is, the essive case is used for static events such as in (132):

- (132) Toini on sairaa-na.
Toini-N be.3S ill-ESS
‘Toini is ill.’

The translative similarly is used to mark properties, but the entailment is that the property holds at the end of the event, i.e., the state is cofinal with the event, rather than being static, and holding for the duration of an event.

In examples where the secondary predicate would receive a pseudo-resultative interpretation like (133a), translative case is not possible:

- (133) a. * Mari leti-tt-i hiuksensa tiuka-ksi.
 Mari braid-CAUS-PAST hair-ACC.POSS tight-TRANS
- b. * Jussi sitoï kengännauhansa tiuko-i-ksi.
 Jussi tied shoelaces-ACC.POSS tight-PL-TRANS
- c. * Mari kasasi tyynyt korke-i-ksi.
 Mari piled pillows high-PL-TRANS

These examples semantically fall into the class of pseudo-resultatives, since the predicate would not be modifying the direct object as the result of the event. Some of these sentences can be formulated with an adjectival predicate; however the adjective must be marked with illative, rather than translative, case³:

³The example in (133c) cannot be formulated with illative case:

- (1) * Mari kasasi tyynyt korkea-an.
 Mari piled pillows high-ILL
 ‘Mari piled the pillows high.’

As in English, the adverb is not possible either:

- (2) * Mari kasasi tyynyt korkea-sti.
 Mari piled pillows high-ADV
 ‘Mari piled the pillows high.’

It is not clear why an illative-marked adjective is not possible in (1). Nevertheless, the lack of availability of translative case in this and other cases supports the conclusions drawn above regarding English and the contrasts between resultatives and pseudo-resultatives.

- (134) a. Mari leti-tt-i hiuksensa tiukka-**an**.
 Mari braid-CAUS-PAST hair-ACC.POSS tight-ILL
 ‘Mari braided her hair tight.’
- b. Mari satoi kengännauhansa tiukka-**an**.
 Mari tied shoelaces-ACC.POSS tight-ILL
 ‘Mari tied her shoelaces tight.’

The illative case is a locative case which is the cofinal variant of the static inessive case. Inessive case marks locations which an entity is in for the duration of an event, such as in (135).

- (135) a. Toini on talo-ssa
 Toini-N be.3S house-INE
 ‘Toini is in the house.’

Illative is used when the entity is in a location at the end of an event, or in more metaphorical ‘locative’ contexts. Karlsson (1999) gives the following examples of both uses:

- (136) a. Isä ajaa auton autotalliin.
 father drives car-ACC garage-ILL
 ‘Father drives the car into the garage.’
- b. Hän pani avaimen lukkoon.
 S/he put key-ACC lock-ILL
 ‘He put the key into the lock.’
- c. Käteen tuli haava.
 hand-ILL came wound
 ‘The hand was wounded.’ (lit: Into the hand came a wound)

The presence of this distinct locative marking on pseudo-resultatives, as opposed to translative marking in resultatives, provides morphological support for the contrast in

structure between resultatives and pseudo-resultatives in Finnish^{4, 5}.

We can derive this contrast if we assume that, as in English, Finnish verbs occurring with pseudo-resultative predicates are implicit creation verbs which must be decomposed with the presence of the locative heads IN and TO. Illative case is assigned by the elements IN and TO, which are not present in resultative constructions. The analysis of this

⁴Some speakers accept illative case marking also in cases like (1), where the illative-marked element seems to receive a manner adverb interpretation:

- (1) % Mari juoksi nopea-an.
Mari ran quick-ILL
'Mari ran quick.'
- (2) Mari juoksi nopea-sti.
Mari ran quick-ADV
'Mari ran quickly.'

However, illative case marking is not generally available for manner adverbs:

- (3) * Mari juoksi hitaa-seen.
Mari ran slow-ILL
'Mari ran slow.'
- (4) Mari juoksi hitaa-sti.
Mari ran slow-ADV
'Mari ran slowly.'

⁵Some of the examples that are possible as pseudo-resultatives in English are possible with resultative morphology in Finnish:

- i. a. Mari viipal-o-i leivä-n ohue-ksi.
Mari slice-CAUS-PAST bread-ACC thin-TRANS
'Mari sliced the bread into thin slices.'
- b. Mari silppusi persilja-n hieno-ksi.
Mari chopped parsley-ACC fine-TRANS

This may be due to a difference in the specifics of the verbs and/or adjectives and the grammatical realization of these concepts in Finnish vs. English.

structure and its implications will be discussed further in chapter 4.

The same roots that form implicit creation verbs sometimes can also form explicit creation verbs, where the goal is realized as a direct object and the source argument is optional:

(137) She braided a necklace (out of wire). (i.e., a necklace was created by braiding)

For such cases, it is predicted that pseudo-resultatives are possible on the implicit creation verb reading while true resultatives are also possible with the explicit creation verb reading. This is supported by the fact that, in Finnish, translative case is possible when the created object is realized as the DP object argument of the verb:

(138) Mari leti-tt-i leti-n tiuka-ksi.
Mari braid-CAUS-PAST braid-ACC tight-TRANS
'Mari braided the braid tight.'

The relation between such verbs and implicit creation verbs will be addressed in chapter 6.

3.1.2.1.2 Norwegian A contrast between the morphology of resultative predicates and pseudo-resultative predicates can also be found in Norwegian. In Norwegian, resultative predicates are not marked with any special case. However, they do exhibit adjectival agreement with the argument that they modify, as shown in (139).

(139) a. Marit drakk flaskene tomm-e.
Marit drank bottle-DEF.PL empty-PL
'Marit drank the bottles empty.'

b. Marit banket dem flat-e.
Marit hammered them flat-PL
'Marit hammered them flat.'

This agreement, also called concord, is like that seen above in Catalan. Adjectives in Norwegian show two agreement ‘paradigms’, the ‘definite’ paradigm within the DP in prenominal position, and the ‘indefinite’ paradigm in postnominal and predicative positions (Kester 1996). The *-e* suffix marks the plural agreement (which is the same for all genders), and cannot be replaced by the ‘default’, singular neuter marker *-t*:

- (140) a. * Marit drakk flaskene tomm-t.
 Marit drank bottle-DEF.PL empty-N.SG
 ‘Marit drank the bottles empty.’
- b. * Marit banket dem flat-t.
 Marit hammered them flat-N.SG
 ‘Marit hammered them flat.’

In the case of pseudo-resultatives, no such agreement is found (141). Instead there is default singular neuter agreement, no matter the phi-features of any DPs in the sentence (142). In order to illustrate this, all of the objects given have phi-features other than singular neuter, so that such morphology must indicate the default ⁶:

- (141) a. * Marit flettet krøllene sine stramm-e.
 Marit braided curls-DEF.PL REFL tight-PL
 ‘Marit braided her curls tight.’
- b. * Marit knøt skolissene sine hard-e.
 Marit tied shoelace-DEF.PL REFL hard-PL
 ‘Marit tied her shoelaces tight.’
- c. * Marit stablet putene høy-e.
 Marit piled cushions-DEF.PL high-PL
 ‘Marit piled the cushions high.’
- (142) a. Marit flettet krøllene sine stram-t.
 Marit braided curls-the REFL tight-NEUT.SG

⁶Due to the lack of adverb morphology equivalent to *-ly* in Norwegian, it is not trivial to say whether these forms are parallel to morphological adjectives or adverbs in English. See the end of this section.

‘Marit braided her curls tight.’

- b. Marit knøt skolissene sine hard-t.
Marit tied shoelace-DEF.PL hers-PL hard-NEUT.SG
‘Marit tied her shoelaces tight.’
- c. Marit stablet putene høy-t.
Marit piled cushions-the high-NEUT.SG
‘Marit piled the cushions high.’

This lack of agreement shows a clear contrast in Norwegian between resultative predicates and pseudo-resultative predicates. This contrast also allows for disambiguation of sentences which is not possible in English due to the lack of morphology. There are some sentences in English which are ambiguous between resultative and pseudo-resultative readings, as was shown in (36) above. As predicted, this ambiguity does not occur when there is a morphological distinction between the resultative and pseudo-resultative as in Norwegian. In the following Norwegian examples, (143a) with zero agreement on the adjective can only have the resultative interpretation, whereas only a pseudo-resultative interpretation is available with the default non-zero agreement that marks pseudo-resultatives as in (143b):

- (143) a. Marit skjærte kaka tynn-∅.
Marit cut cake-DEF.F thin-M/F.SG
‘Marit cut the cake into thin slices.’
- b. Marit skjærte kaka tyn-t.
Marit cut cake-DEF.F thin-NEUT.SG
‘Marit cut the cake thin.’ (i.e., the entire cake is made thin)

This agreement contrast is unsurprising, considering the fact that the pseudo-resultative does not semantically modify the direct object. However, it is surprising in the context of the Catalan data above, as Norwegian shows a different agreement pattern. In Catalan,

adjectival agreement with the object DP was possible with pseudo-resultatives despite the lack of semantic predication. It was argued that this was due to the purely syntactic nature of such agreement in Catalan. There are several possible reasons that the Norwegian agreement facts come out differently. One possibility is that there is an additional semantic restriction on agreement in Norwegian. The prediction would be that one would find other cases of apparent mismatch between agreement and predication in Catalan, but not in Norwegian. Another possibility is that the pseudo-resultative predicates in Norwegian involve a different syntactic position, as proposed for predicates with adverb morphology in English in section 3.1.1.3. The collection of data necessary to determine which of these hypotheses is correct must be left to future work.

3.1.2.2 Cross-linguistic Availability of Pseudo-Resultatives

The semantic and syntactic differences between resultatives and pseudo-resultatives predict that they might have a different distribution cross-linguistically. As shown by Mateu (2000), Romance languages such as Catalan lack canonical resultatives (144), but, as shown in in section 3.1.1.1 and repeated in (145), do have pseudo-resultatives:

- (144) a. *El cambrer fregà els plats secs.
 the waiter wiped the dishes dry-PL
 ‘The waiter wiped the dishes dry.’
- b. *El gos bordà els pollastres desperts.
 the dog barked the chickens awake-PL
 ‘The dog barked the chickens awake.’
- c. *El riu es congelà sòlid.
 the river ES-REFL froze solid-SG
 ‘The river froze solid.’
- (145) a. M’ he lligat els cordons de les sabates (ben) estrets.
 me-DAT have-1st tied the laces of the shoes (very) tight-PL

‘I tied the laces of my shoes very tight.’

- b. Talla-les menudes.
Cut-them fine-PL
‘Cut them fine (i.e., into fine pieces).’

Mateu (2000) attributes this contrast between Romance languages and languages like English to the fact that the former are ‘verb-framed’ in the sense of Talmy (1991), while the latter are ‘satellite-framed’. The verb-framed nature of Romance languages prevents a necessary conflation operation. This conflation operation is not necessary to account for the combination of implicit creation verbs with pseudo-resultative predicates, and thus the availability of pseudo-resultatives in contrast with resultatives in Catalan is consistent with this account.

3.1.2.3 Particles

If pseudo-resultatives were syntactically equivalent to resultatives, this predicts that these should have the same syntactic distribution. One respect in which their distribution seems to differ is in their combination with aspectual particles. In order to test this hypothesis, we must first establish the behavior of resultatives with particles. There is some controversy in the literature over the interaction between particles and resultatives, both in English and other languages such as Dutch. Den Dikken (1995) presents the following data, with the first coming from Jackendoff (1977)⁷:

⁷Examples such as those in (1) won’t be considered here, as the resultative constituents are not APs, and are arguably not entirely syntactically parallel:

- (1) a. They brought him up a catholic.
- b. They put the books down on the shelf.
- c. They sent the stockholders out a schedule.

- (146) a. They painted the barn up red. (second position)
 b. *? They painted up the barn red. (first position)
 c. * They painted the barn red up. (third position)

From these examples, it would appear that the resultative is compatible with a verbal particle, as long as that particle is in the post-object, pre-resultative position, which I will call the ‘second position’. There is a consensus in the literature that the particle in third position is bad in combination with the resultative, and that the particle in first position is severely degraded. However, there is not a consensus about the status of the resultative with the particle in second position, and thus whether there is any position for the particle in which it is felicitous in combination with a resultative. While Jackendoff and den Dikken argue that this example is grammatical, some assume otherwise in treating verb particles and resultatives as elements in complementary distribution⁸. Kayne (1985) argues that verb particles and resultatives should be analyzed on a par, with both serving as the predicate of a small clause. Thus, the examples in (146) would be on a par with those in (147):

- (147) a. They made John out a liar.
 b. *? They made out John a liar.
 c. * They made John a liar out.

⁸It must be noted that at least some speakers also find this particular sentence without the resultative predicate to be ungrammatical, although it is unclear whether this is for the same speakers that do accept the combination of the particle with the resultative:

- (1) ? They painted the barn up.

Given that these have the same syntactic position, one would expect them to be in complementary distribution. Ramchand (2006) similarly analyzes particles and resultatives as being merged in the same position, and thus complementary. She argues that both are merged as a part of a resultative phrase, or resP:

(148) a. Alex handed (in) her homework (in).

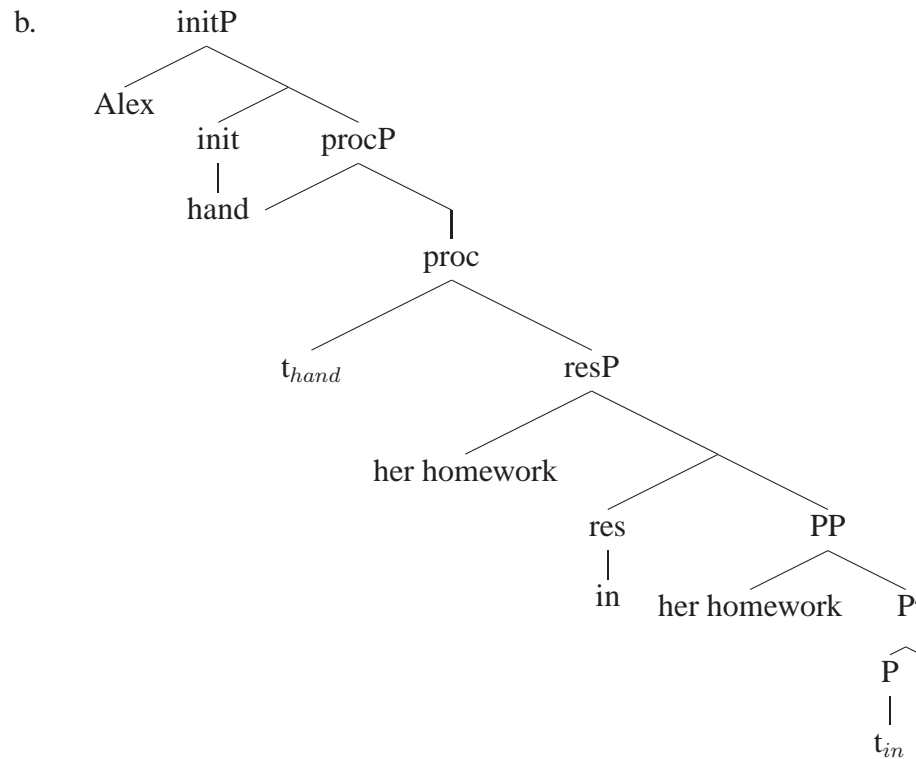

(149) a. Karena hammered the metal flat.

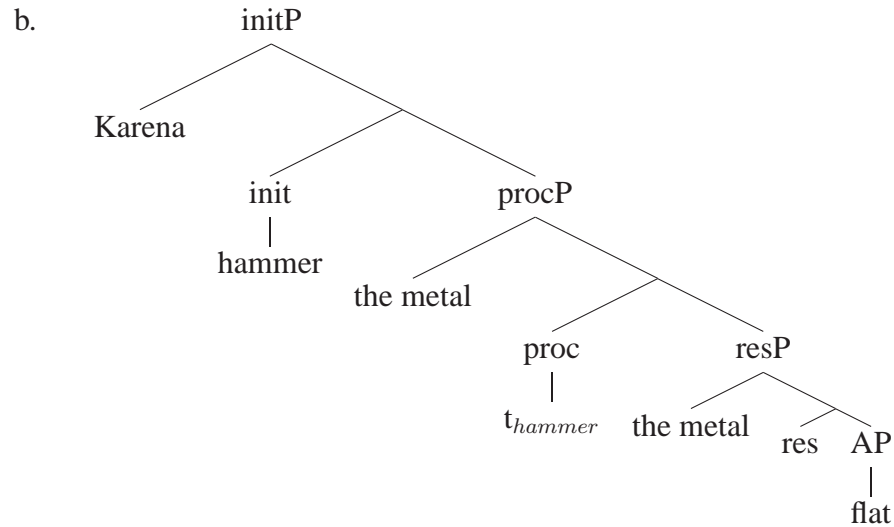

On Ramchand's analysis, both the particle and the resultative head a constituent which is merged as the complement of res^0 . The particle then obligatorily moves to the res^0 position, while the resultative predicate may stay *in situ*.

Neeleman (1994), addressing similar data in Dutch, also argues that verb particles and resultatives are in complementary distribution, with data as in (150):

- (150) a. dat Jan zijn moeder **op**-belt
 that John his mother up-phones
- b. dat Jan zijn moeder **gek** belt
 that John his mother crazy phones
- c. * dat Jan zijn moeder **gek op**-belt
 that John his mother crazy up-phones

Neeleman argues that apparent counterexamples like (151) do not in fact include resultatives, as they receive a different interpretation⁹:

⁹According to Marcel den Dikken (p.c.), the secondary predicate in the similar example in (1) can receive a resultative interpretation:

- (1) dat Jan de deur groen over-verft
 that John the door green over-touches

- (151) dat Jan de deur groen bij-verft
 that John the door green up-touches
 ‘that John touched the door up green’

According to Neeleman, this sentence does not entail the result that the door is green; rather a part of the door is green, the part that is ‘touched up’. In this sense, the predicate resembles a pseudo-resultative, rather than a resultative.

The particles that co-occur with implicit creation verbs are of the ‘aspectual’ type, such as *up* and *out*. While there is much work to be done on the semantics of such particles, they are generally analyzed as relating somehow to the completion of the event which they modify, as opposed to directional particles which may indicate the final position of an argument of the verb. As with resultatives, sentences with pseudo-resultatives in combination with particles in first position are degraded¹⁰:

- (152) a. ? Mary braided up her hair tight.
 b. ? Mary tied up her shoelaces tight.
 c. ? Mary piled up the cushions high.
 d. ? Mary chopped up the parsley fine.
 e. ? Mary sliced up the bread thin.
 f. ? Mary ground up the coffee beans fine.

‘that John painted the door over green’

However, since the particle *over* seems to entail covering the door with paint, it is less clear how to unambiguously distinguish the readings for this example.

¹⁰Some speakers find improvement of these examples with the addition of *real*:

- (1) ? Mary braided up her hair real tight.

However, pseudo-resultative predicates are not generally judged as degraded in combination with second-position particles (153):

- (153) a. Mary braided her hair up tight.
b. Mary tied her shoelaces up tight.
c. Mary piled the cushions up high.
d. Mary chopped the parsley up fine.
e. Mary sliced the bread up thin.
f. Mary ground the coffee beans up fine.

Thus these judgments seem to differ from the judgments of some for resultatives. However, the judgments for the resultatives are nuanced, and thus it is difficult to evaluate to what extent the pseudo-resultatives truly contrast with the resultatives in this respect. In order to determine whether there is an interaction between secondary predicate type and the presence of aspectual particles, a web-based judgment experiment was conducted.

The experiment was designed to test two hypotheses. The first hypothesis was whether there was a significant difference between judgments of a set of verbs with both resultative predicates and particles in second position in contrast with the same verb phrases without the secondary predicate or the particle. The finding was that there is a significant degradation in judgments in the sentences with resultative predicates that is dependent upon the presence of the particle.

The second hypothesis tested was whether pseudo-resultatives show a pattern distinct from that of resultatives with respect to combination with verb particles in second position. This hypothesis was confirmed, supporting the more general hypothesis that pseudo-resultatives are syntactically distinct from resultatives.

3.1.2.3.1 Methods

3.1.2.3.1.1 Participants The subjects were 93 native English speakers who volunteered for the study.

3.1.2.3.1.2 Materials The first hypothesis tested was that the combination of a resultative predicate and the aspectual particles *up* and *out* in second position is degraded in acceptability in comparison with the same verb phrase containing only one or the other. Testing this hypothesis required varying two factors - the presence of the resultative predicate and the presence of the second position particle. In addition, the sentences were tested with a first position particle in order to situate the judgments against a combination which has been less controversially determined to be ungrammatical in the literature.

This creates a 2 (resultative) by 3 (particle position) design, illustrated in Table 3.1, where the conditions names and references to example stimuli in the list below are provided in each cell.

Presence of Resultative	No Particle	1st Position Part.	2nd Position Part.
No Resultative Predicate	RV-NoPred-NoPart (160a)	RV-NoPred-Part1 (160b)	<i>RV-NoPred-Part2</i> (160c)
Resultative Predicate	<i>RV-Pred-NoPart</i> (160d)	RV-Pred-Part1 (160e)	<i>RV-Pred-Part2</i> (160f)

Table 3.1: 2 (resultative presence) by 3 (particle position) Design

The condition name RV-Pred-NoPart expands to ‘resultative verb, with predicate, no particle’, as exemplified in (154):

(154) In ten minutes, Mary smoothed the ribbons flat.

A temporal preposition phrase was used for each stimulus so as to control for the resultative, versus depictive, interpretation of the secondary predicate. Without this phrase,

sentences such as (155) are ambiguous as to whether the secondary predicate is interpreted as a resultative or object depictive:

(155) Mary smoothed the ribbons flat.

What is meant by ‘resultative verb’ above is a verb that occurs with resultatives, versus implicit creation verbs for example, which only occur with pseudo-resultatives. The verbs used with resultative predicates include *smooth*, *grill*, *cook*, *fry*, *paint*, and *cut*. This verb group disambiguates the type of predicate that can occur in the given example, so that only ‘Pred’ is specified. The prediction made by the hypothesis is that judgments for condition RV-Pred-Part2, resultatives with particles in second position, will be significantly degraded in comparison with RV-Pred-NoPart, resultatives with no particle.

- (156) a. In ten minutes, Mary smoothed the ribbons flat.
b. In ten minutes, Mary smoothed the ribbons out flat.

In order to determine that this effect is due to the combination of the secondary predicate with the particle, and not solely presence of the particle with the relevant verb, the condition RV-NoPred-Part2, particles in second position with no resultative predicate, is added as a control:

(157) In ten minutes, Mary smoothed the ribbons out.

Further, the condition RV-NoPred-NoPart, with no particle or secondary predicate, is added as a control for the improvement of RV-NoPred-Part2 solely due to an avoided incompatibility of the verb with the resultative, rather than absence of the particle.

(158) In ten minutes, Mary smoothed the ribbons.

The conditions RV-NoPred-Part1 and RV-Pred-Part1 are present for comparison of degree of degradedness with particles in first position, as discussed above.

- (159) a. In ten minutes, Mary smoothed out the ribbons.
b. In ten minutes, Mary smoothed out the ribbons flat.

In sum, the range of stimuli across conditions used to test this hypothesis are exemplified in (160):

- (160) a. In ten minutes, Mary smoothed the ribbons.
b. In ten minutes, Mary smoothed out the ribbons.
c. In ten minutes, Mary smoothed the ribbons out.
d. In ten minutes, Mary smoothed the ribbons flat.
e. In ten minutes, Mary smoothed out the ribbons flat.
f. In ten minutes, Mary smoothed the ribbons out flat.

The second hypothesis was that pseudo-resultatives do not show the same degree of degradation in combination with second position particles as resultatives. The prediction is that sentences with particles in second position with pseudo-resultatives will be judged significantly better than sentences with particles in second position with resultatives, even though these predicates in the absence of the particle are judged the same. In other words, the presence of a second position particle should more severely degrade sentences with resultatives than those with pseudo-resultatives.

Testing the second hypothesis required examining the interaction of the pseudo-resultative predicate with the particle in the same way as done for the resultative predicate above. Here again the particle is either absent or in first or second position, now always in combination with a secondary predicate. However, the predicate is varied not by presence/absence of the resultative, but for predicate type - resultative or pseudo-resultative. This gives a 2 (predicate type) by 3 (particle position) design, illustrated in Table 3.2. The same condition name conventions as above are used, with the abbreviation ICV added for

‘implicit creation verb’, or those verbs that occur with pseudo-resultatives, as opposed to RVs, ‘resultative verbs’. The stimuli for the resultative predicates are the same as those cited above.

Predicate Type	No Particle	1st Position Part.	2nd Position Part.
Pseudo-Resultative Predicate	ICV-Pred-NoPart (161a)	ICV-Pred-Part1 (161b)	ICV-Pred-Part2 (161c)
Resultative Predicate	RV-Pred-NoPart (161d)	RV-Pred-Part1 (161e)	RV-Pred-Part2 (161f)

Table 3.2: 2 (predicate type) by 3 (particle position) Design

- (161) a. In one minute, Jane braided the ribbons tight.
 b. In one minute, Jane braided up the ribbons tight.
 c. In one minute, Jane braided the ribbons up tight.
 d. In ten minutes, Mary smoothed the ribbons flat.
 e. In ten minutes, Mary smoothed out the ribbons flat.
 f. In ten minutes, Mary smoothed the ribbons out flat.

In addition to these stimuli, control sentences were also included which are minimal pairs with the pseudo-resultative stimuli presented in the design above, lacking the pseudo-resultative predicate:

- (162) a. In one minute, Jane braided the ribbons.
 b. In one minute, Jane braided up the ribbons.
 c. In one minute, Jane braided the ribbons up.

In all, six sets of 12 sentences with the above properties were designed. Each set of sentences consisted of six sentences with verbs that occur with resultative predicates

(‘resultative verbs’) and six sentences with the verbs that occur with pseudo-resultative predicates, such that there were two verbs per set, as in (163).

- (163)
- a. In ten minutes, Mary smoothed the ribbons.
 - b. In ten minutes, Mary smoothed out the ribbons.
 - c. In ten minutes, Mary smoothed the ribbons out.
 - d. In ten minutes, Mary smoothed the ribbons flat.
 - e. In ten minutes, Mary smoothed out the ribbons flat.
 - f. In ten minutes, Mary smoothed the ribbons out flat.
 - g. In one minute, Jane braided the ribbons.
 - h. In one minute, Jane braided up the ribbons.
 - i. In one minute, Jane braided the ribbons up.
 - j. In one minute, Jane braided the ribbons tight.
 - k. In one minute, Jane braided up the ribbons tight.
 - l. In one minute, Jane braided the ribbons up tight.

Each sentence started with an temporal prepositional phrase. This was to control for the correct reading of the secondary predicates as resultative or pseudo-resultative, rather than depictive. Across the verb groups, the object DP was the same throughout each set of sentences.

In order to provide a full range of judgments across the scale, anomalous sentences of a shape similar to the above stimuli were included (6 total, repeated in all lists), such as those in (164):

- (164)
- a. In three minutes, Sarah smiled the ham up.
 - b. In two minutes, Tom ran up the tomatoes fine.

There were also many fillers (42 per list) from an unrelated experiment with a different sentence shape.

3.1.2.3.1.3 Procedure The 12 conditions were divided into 6 lists to ensure that subjects did not see the same verb twice. The stimuli were administered via an online, web-based survey. Subjects were provided with instructions which presented an example stimulus. They were instructed to select a radio button to assess each sentence presented for naturalness, on a scale of 1 (not at all natural) to 7 (completely natural). After reading the instructions, the subject clicked a 'begin' button and was presented with the first of 60 sentences: 12 stimuli (2 per condition of 6 conditions), 6 anomalous sentences, and 42 fillers. The time between presentation of the stimulus and the subject's response was recorded along with their selection from the scale. After the subject made a radio button selection, the next stimulus was presented immediately. The experiment took approximately 10 minutes for each subject to complete.

3.1.2.3.2 Results All trials that took more than one minute were eliminated from the analysis. While some subjects used the full range of the scale from 1 to 7, others only used a subset of the scale. Thus, all judgments were converted from a raw score on a scale of 1 to 7 to z scores based on within-subject means and standard deviations. The z scores make it possible to normalize for these differences between subjects and compare conditions across subjects.

The first hypothesis which was investigated was whether resultative predicates are more degraded with second position particles than in sentences without particles. The results relevant to this comparison are presented in (3.1).

A 2 (predicate presence) by 3 (particle position) between-subjects ANOVA was conducted on this data. The results show that there was a main effect for presence of the

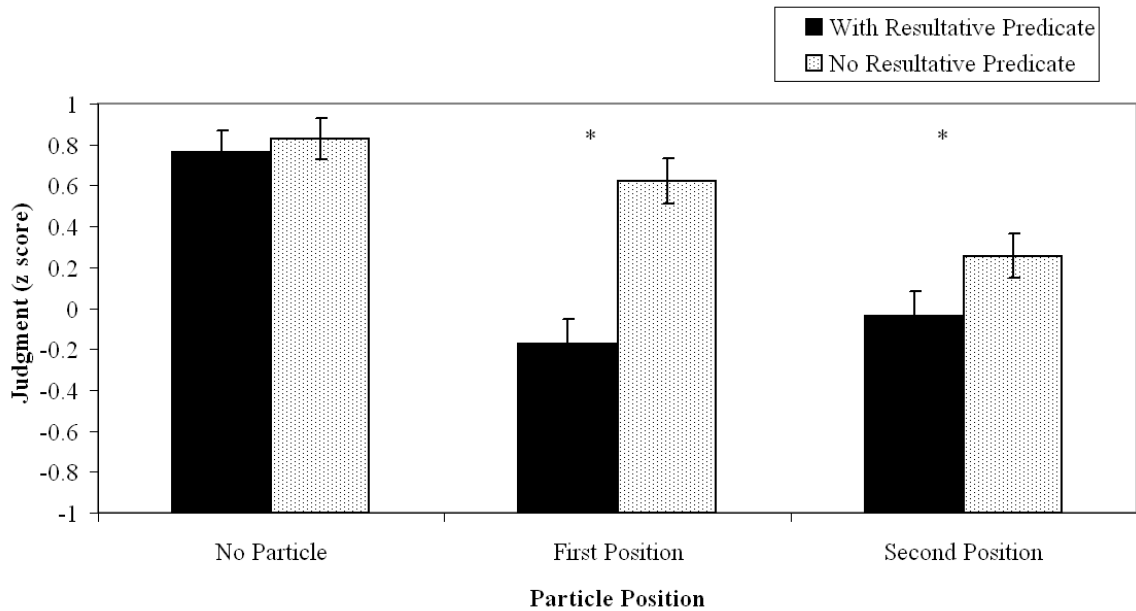

Figure 3.1: VPs With vs. Without Resultative Predicates

resultative predicate, such that, across sentences with or without particles in various positions, those with resultatives were significantly worse than those without, $F(1,273) = 37.91, p < .001$. There was also a main effect of particle position, $F(2,273) = 48.10, p < .001$. Crucially, there was a significant interaction between the resultative predicate and the particle presence/position such that introduction of the particle degraded sentences with predicates more than those without predicates, $F(2,273) = 12.8, p < .001$.

To understand the nature of this interaction, three planned comparisons were made between the means at each level of the particle factor, using the Bonferroni-Dunn procedure. When no particle was present, there was no significant difference between whether there was a predicate or not, as expected. This confirms that overall, resultative predicates do not degrade sentences without particles. Also as expected, there was a difference between the particle in first position in combination with a resultative predicate ($M = -0.17$),

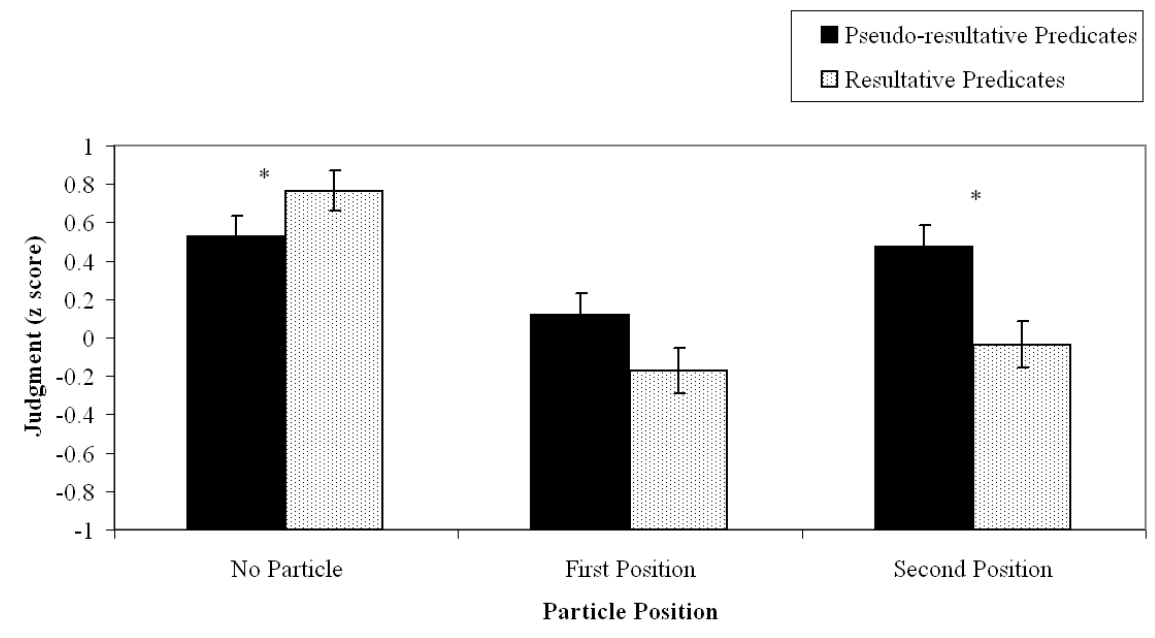

Figure 3.2: Pseudo-Resultative vs. Resultative Predicates

and without a resultative predicate ($M = 0.62$), which was significant, $t(86) = 6.73$, $p < .01$, corrected. This confirms the consensus view in the literature that resultatives in combination with first position particles are worse than the same sentences without the resultative predicates. Most crucially, as predicted by the hypothesis, a similar effect is seen between second position particles with and without resultative predicates. Second position particles with resultative predicates ($M = -0.01$) were worse than second position particles without resultative predicates ($M = 0.26$), and this was a significant difference, $t(86) = 2.64$, $p < .05$, corrected.

Having established that there is a significant difference between second position particles with versus without resultative predicates, it is possible to test the second hypothesis, that pseudo-resultatives, being distinct from resultatives, do not show this same behavior. The results relevant to this hypothesis are shown in figure 3.2.

A 2 (predicate type) by 3 (particle position) between-subjects ANOVA was conducted. The data show that there was a main effect for the type of secondary predicate such that sentences with a secondary predicate were overall judged worse than those without, $F(1,273) = 7.31, p < .01$. There was also a main effect of particle position, such that sentences without particles were judged better than those with particles in either position overall, $F(2,273) = 37.49, p < .001$. Crucially, there was a significant interaction between predicate type and particle position, such that introduction of the particle degraded sentences with resultative predicates more than those with pseudo-resultative predicates, $F(2,273) = 11.33, p < .001$.

To understand the nature of this interaction, three planned comparisons were made between the means at each level of the particle factor, using the Bonferroni-Dunn procedure. When no particle was present, judgments of sentences with resultative predicates ($M = 0.77$) were better than those with pseudo-resultative predicates ($M = 0.53$), and this difference was significant, $t(87) = -2.67, p < .05$ corrected. With the particle in first position, the resultative was on average worse than pseudo-resultative, but this trend did not reach significance, $p = .06$, corrected. Importantly, as predicted, with the particle in second position, judgments of sentences with resultatives ($M = -0.01$) were lower than those with pseudo-resultative ($M = 0.47$), and this difference was significant, $t(90) = 4.07, p < .01$ corrected. This confirms the hypothesis that pseudo-resultatives interact differently with particles than resultatives, and thus this provides further evidence that the two types of secondary predicate are syntactically distinct.

3.1.2.3.3 Discussion The experiment showed, first of all, that sentences with both resultative secondary predicates and particles in second position are degraded in comparison with the same sentences minus the resultative predicate. This effect was not due to

any general degradation due to the presence of the resultative predicate, as can be seen by the lack of difference between the conditions with no particles. The experiment thus sheds light on a controversy in the theoretical literature, supporting theories which can account for this degradation.

The results further confirm the hypothesis that pseudo-resultative predicates do not show the same degradation in combination with the second position particle. This supports the larger hypothesis put forth in this section that pseudo-resultative predicates are syntactically distinct from resultatives, and thus do not lead to the same degree of degradation as resultatives in this context.

3.1.3 Section Summary

In this section, it has been shown that pseudo-resultative modification is syntactically distinct from adverbial modification and resultative modification. The analysis of pseudo-resultative predicates as modifiers of a subconstituent of the verb, the root, has been syntactically motivated. In the next section, the status of this element as a root as opposed to a noun will be addressed.

3.2 Root-Derived vs. Noun-Derived Verbs

I have argued above for the syntactic complexity of verbs, in particular implicit creation verbs, and shown how the complex verb is derived from a lexical element which I have called the 'root'. It has been shown that the lexical element does not belong to the lexical category 'verb' directly, but only via derivation. What has not yet been shown is how this root relates to the lexical category of 'noun'. The roots of implicit creation verbs have been argued to be of type $\langle e,t \rangle$, predicates of individuals. This is the same type

often ascribed to ‘common nouns’. Further, verbs derived from such roots are usually described as ‘denominal’, with the claim being either explicitly or implicitly that there is a noun present in the derivation of the verb, at some level of representation. In order to address this issue further, it is necessary to establish some concrete notion of what constitutes a noun. Only then can it be determined whether the root of implicit creation verbs is a noun in this sense.

3.2.1 Nouns vs. Roots

The approach to this question that I will adopt is that of Marantz (2000, 2006). Marantz argues that nouns are derived categories which result from the combination of an *n* head with some constituent, either a root or a phrase. This *n* head is a phasal head, in the sense of Chomsky (2001b), such that it establishes a domain for phonological spellout and semantic interpretation. The prediction of this analysis with respect to the category N is that all nouns are ‘frozen’ phonologically and semantically. That is, once the *n* head is merged and a phase is established, the domain for spellout and interpretation is established and the properties within this domain cannot be internally modified, only added to. This theory of phasal categorizing heads provides an account for contrasts previously ascribed to word-building that takes place in the lexicon versus word-building that takes place in the lexicon.

Kiparsky (1982) argued that, of verbs in English which appear to be zero-derived from nouns, some are actually derived from nouns, or denominal while others are underived, and only related to phonologically similar nouns in the lexicon. From the perspective of Marantz’s work, this contrast can be viewed instead as one between noun-derived and root-derived verbs, where the latter are derived directly from a category-neutral root, and the former are derived from a category-neutral root which has already combined with a

categorizing head. The most simple representation of this contrast would be as in (165):

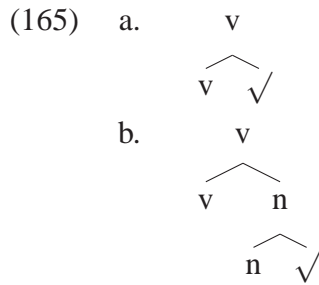

The predictions would be that roots combining directly with *v* would show the range of interpretations and spellouts compatible with a verbal context, while those that are merged with *n* before *v* would only contribute interpretations and spellouts specified for a nominal context. Further, one should find a correlation between the frozen form and frozen meaning. In the following sections it is shown how these predictions are borne out and how the accounts for the contrast between word- and root-derivation can be extended to implicit creation verbs.

3.2.2 Implicit Creation Verbs and Semantic Effects of Categorization

Kiparsky (1982) argues that verbs which are derived from nouns will contain the meaning of the noun, while verbs which are only related lexically to nouns will show a less strict meaning correspondence. Kiparsky argues that the verbs in (166) may be analyzed as derived from nouns, but (167) should not:

- (166) a. She taped the picture to the wall with tape/*pushpins.
 b. They chained the prisoner with a chain/*rope.
- (167) a. He brushed his coat with his brush/hand.
 b. I paddled the canoe with a paddle/copy of the New York Times.

Kiparsky observes that verbs like *tape* and *chain* are not semantically compatible with instruments other than that named by the root of the verb. He argues that this is because in denominal verbs, the meaning of the noun which derives the verb must be included in the meaning of the verb. Verbs like *brush* and *paddle*, on the other hand, are compatible with distinct instruments. Thus he argues they cannot be denominal.

This argument can be reconstructed from the perspective of Marantz (2000) such that the verbs which Kiparsky argues cannot be denominal are not underived, but rather derived from roots¹¹. Arad (2003) provides evidence from Hebrew showing that, although one root may have different meanings and spellouts associated with it (Multiple Contextualized Meaning, or MCM), once the root combines with a categorizing head, the lexical semantics of the root is frozen to be the one that is consistent with that head. This is illustrated with the data in Table 3.3 (Arad 2003:746), which shows the various words that can be formed from the root $\sqrt{\text{sgr}}$, all related to the concept of closure. The ‘template’ column lists various templates for deriving words from roots, where C is a variable ranging over root consonants. Thus combining the root $\sqrt{\text{sgr}}$ with the template CaCaC produces the word *sagar*, the verb ‘close’. It can be seen that $\sqrt{\text{sgr}}$ itself is not specified for any lexical categories such as verb or noun, as there is no basic word form in common between the various realizations. What these words share is only the root. No word in Table 3.3 contains any other word in the table, and thus they cannot be derived from each other.

All of the words derived from $\sqrt{\text{sgr}}$ contain the same root consonants, but different words can be formed from the same root by combination with different heads.

¹¹This does not address the question of whether or not ‘zero-derived’ verbs like *tape* in English are in fact derived from nouns. For recent work on potential contrasts between root-derived and noun-derived verbs cross-linguistically, see also Don (2005) and Rimell (2006)

	Template	word	gloss
a.	CaCaC (v)	sagar	'close'
b.	hiCCiC (v)	hisgir	'extradite'
c.	hitCaCCeC (v)	histager	'cocoon oneself'
d.	CeCeC (n)	seger	'closure'
e.	CoCCayim (n)	sograyim	'parentheses'
f.	miCCeCet (n)	misgeret	'frame'

Table 3.3: Hebrew Templates and Words

The root can give rise to words of different syntactic categories, with different meanings. However, when there is affixation to an already categorized word, the derived word may only use the denotation associated with that categorization. For example, Arad draws a contrast between root-derived and noun-derived verbs. The root $\sqrt{\text{sgr}}$ gives rise to many forms, including the noun *misgeret*, 'frame'. There is then a noun-derived verb based on the word *misgeret*, *misger*, which cannot be derived directly from the root $\sqrt{\text{sgr}}$. This verb, meaning 'to frame', cannot, for example, also mean 'to close', although 'close' is a verb based on the same root, $\sqrt{\text{sgr}}$, in the form of *sagar*. Arad argues that this is a general property of word-derived categories as opposed to root-derived ones, which should extend to English as well, although the morphological derivation from the root to various categories is not always so transparent in English.

Arad (2003) proposes the following locality constraint, based on Marantz (2000):

- (168) Locality constraint on the interpretation of roots: roots are assigned an interpretation in the environment of the first category-assigning head with which they are merged. Once this interpretation is assigned, it is carried along throughout the derivation. (Arad 2003:p.747)

Thus, one piece of evidence that implicit creation verbs can be root-derived rather than noun-derived comes from the fact that there are verbs such as *chop* for which the zero-

related noun does not have a canonical interpretation equivalent to the object(s) created by the event denoted by the verb:

(169) She chopped the parsley fine. → a (fine) chop (of parsley)

Although *chop* can be used as a noun, it is not used to describe the pieces of parsley created by the chopping event. It is in its noun usage more restricted to cuts of meat or the motions of a knife or some other instrument. Assuming Arad (2003)'s view of lexical semantic 'freezing' described below, this is evidence for independent derivation from the same root, rather than derivation of one form from the other.

3.2.3 Implicit Creation Verbs and Irregular Verbal Morphology

On Kiparsky's 1982 view of denominal verbs, irregular past tense morphology is an indication that a word is not denominal. This is based on the assumption that verbs which are built from nouns in the syntax do not have accessible irregular verbal forms listed in the lexicon. Truly denominal verbs will always have regular morphology which is affixed to the nominal form. Thus verbs like 'string', with past tense *strung*, or 'sting', with past tense *stung*, cannot be derived from nouns. The verb 'ring' may be denominal when it has the past tense *ringed*, but not when it has the past tense *rang*.

(170) The phone rang/*ringed. (underived)

(171) Lights *rang/ringed the trees. (denominal)

As proposed by Rimell (2006), from the perspective of Marantz (2000), this can be reinterpreted as evidence for derivation from the root rather than from a noun.

In the composition of implicit creation verbs, it is the predicate of individuals denotation that is initially selected by INTO, yet the final spellout is that of a verbal syntactic

context. This can be seen with implicit creation verbs which have irregular past tense morphology such as *grind*:

- (172) a. He grinds the coffee fine.
b. He ground the coffee fine.

This irregular morphology is evidence that *grind* is not a denominal verb, but rather is derived from the root.

These data also support the Distributed Morphology hypothesis that there is late insertion of phonological information, since it is the larger syntactic context which determines the spellout of the root. If spellout of a root were determined at merge, then the phonological form would be strictly tied to the selected denotation. However, we see here with the case of *grind* that there is not a one-to-one mapping between the denotation and the spellout.¹²

3.3 Summary

In this chapter, it was shown that implicit creation verbs are derived from lexical elements of the category ‘root’, and that these roots may be syntactically modified by pseudo-resultative APs. It was shown that this analysis has better empirical coverage than those which analyze the verb as syntactically simplex, or those that analyze pseudo-resultative predicates as being VP-adjunct adverbs or resultative APs. In the next chapter I will show

¹²Alternatively, it is possible that the implicit creation verb context is separately listed for the root and happens to share the same spellout as the explicit creation verb spellout. If this were the case, we would expect to find a language where the two receive different spellouts. I am not currently aware of any such data.

how the structure proposed thus far combines with functional structure in order to build the rest of the verb phrase.

Chapter 4

The *vP* Structure of Implicit Creation

Verbs

In chapter 2, a semantic lexical decomposition of implicit creation verbs was proposed, and in chapter 3 the lower part of that decomposition was argued to be reflected in the syntax. The lexical material was argued to be contributed by a category-neutral root. There are several ways in which this root could merge with further functional elements in the syntax to produce a *vP*. There have been previous proposals for other types of verbs for deriving such *vPs*. In this chapter, I will argue that these previous proposals do not extend to implicit creation verbs, and that a structure reflecting the semantic composition proposed in chapter 2 is necessary. In this chapter, I will present the data illustrating these contrasts. In chapter 6 a view of root ontology to account for these contrasts will be presented.

There are four primary syntactic hypotheses that must be addressed. One possibility is that the syntax of implicit creation verbs mirrors that of inchoative verbs such as proposed for *open* in Harley (1995) and others following, such that the root takes the direct object

as an argument and then this \sqrt{P} combines with v , as in (173):

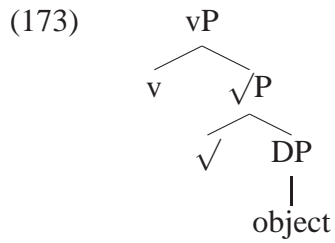

Another hypothesis would be that the root combines with v as a manner modifier, and this constituent then takes the DP object as an argument, as proposed for explicit creation verbs like *bake* in Marantz (2007):

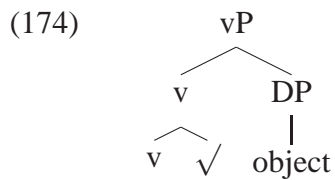

The structure could also be a relational one like that proposed for the semantic decomposition in chapter 2, but with the opposite relational order, as in (175):

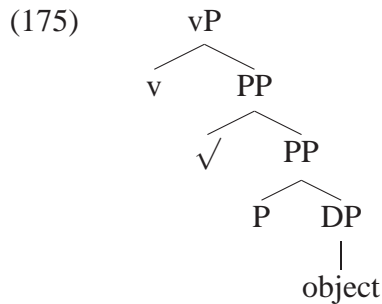

I will argue against all of these hypotheses, and in support of a structure which reflects the semantic structure proposed in chapter 2, as in (176). The movement arrows represent the conflation of the root and relational heads with the v head and *voice* to form the verb:

(176)

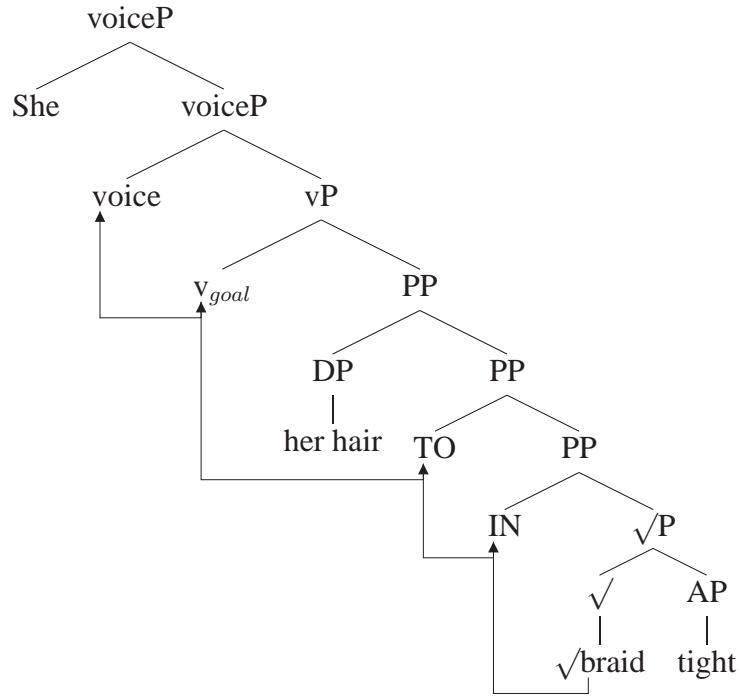

4.1 Implicit Creation Verbs vs. Inchoative Verbs

One type of derivation of verbs from roots that has been proposed in the literature is for inchoative verbs like *open*. Parsons (1990) and Hale and Keyser (1993) propose that inchoative verbs are deadjectival, while Harley proposes the structure in (177), where an inchoative head selects a \sqrt{P} :

(177)

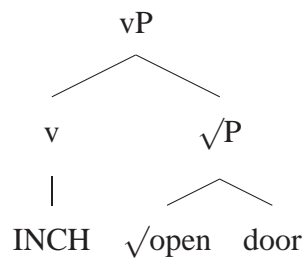

Pylkkänen (2002) and Alexiadou et al. (2006) also treat the ‘adjectival’ root as category-neutral. Pylkkänen (2002) argues that certain cases of apparent ‘verb’ modification found with causative-inchoatives in English are actually root modification, such as with the bolded modifiers in (178) (examples originally from Tenny (2000)):

- (178) a. John closed the door **partway**.
b. John **partly** closed the door.
c. Roger **half** filled the glass.
d. Roger filled the glass **halfway**.
e. Nicolas **mostly** filled the glass.

These modifiers have lower scope than verbal modifiers, such that *partway* in (178a) modifies the state of being closed, not the causing event. This can be seen by the fact that *partway* receives the same interpretation in the inchoative variant in (179):

- (179) The door closed partway.

This is in contrast with verbal modifiers which seem to lack the lower scope reading in causatives, as illustrated in (180) from Pylkkänen (2002):

- (180) a. Bill awoke grumpily.
b. John awoke Bill grumpily. (false if John wasn’t grumpy)

Pylkkänen argues that the low scope illustrated in (178) is root-modification, and therefore inchoative verbs must be root-derived.

In these analyses of inchoative verbs, a stative root combines first with a theme argument before combining with a *v* head. It is syntactically feasible to analyze the roots of the implicit creation verbs in a parallel way, by treating them as stative roots which can take theme objects directly as in (181):

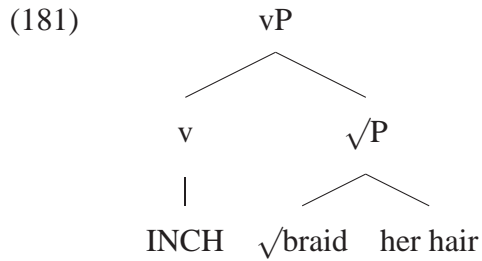

Syntactically, this would be the same context for the root as in the case of inchoative verbs. However, it seems that this structure is somehow blocked, as no implicit creation verbs occur in the non-causative variant like inchoative verbs:

- (182)
- a. * Her hair braided.
 - b. * Her shoelaces tied.
 - c. * The cushions piled.
 - d. * The parsley chopped.
 - e. * The bread sliced.

Thus it does not appear that the roots of implicit creation verbs occur in a structure like that of inchoative verbs. This can also be seen in other contrasts between these types of verbs. When there is an interpretation of transfer of possession of the theme of an inchoative verb, a benefactive applicative, or double object construction, is possible:

(183) She opened Mary a beer.

Implicit creation verbs, however, are not compatible with this kind of applicative argument, even if a transfer of possession interpretation is plausible:

(184) # She braided Mary the rope. (where 'the rope' is the material, not the created object)

(185) * She piled Mary some cookies.

(186) * She sliced Mary the loaf of bread.

Although these verbs are elsewhere compatible with benefactive applicative arguments, it is only with an explicit creation reading, where the theme is not the material from which the created object is created, but is the created object itself:

(187) She braided Mary a necklace.

(188) She sliced Mary a piece of cake.

This contrast will be returned to in chapter 6.

Further, while implicit creation verbs only occur with pseudo-resultatives, not resultatives, inchoative verbs and their causative variants do occur with resultatives, where the secondary predicate modifies the direct object:

(189) The river froze solid.

(190) The wind froze the river solid.

If we want to maintain that both $\sqrt{\text{open}}$ and $\sqrt{\text{braid}}$ are roots which head a $\sqrt{\text{P}}$, these contrasts must be not syntactic in the sense of category selection, but due to the argument structure or other semantic properties of these roots. This contrast will be returned to in the section on root ontology in chapter 6.

4.2 Implicit Creation Verbs vs. Explicit Creation Verbs

Another proposal for the syntactic derivation of verbs from roots has been for the decomposition of verbs in which the root is a ‘manner modifier’. Marantz (2005) argues that creation verbs like *bake* have the structure in (191), where the root combines with a *v* head and then the resulting constituent takes the DP object as an argument:

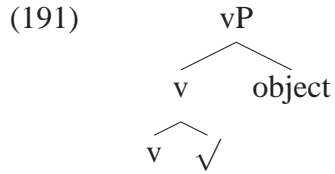

‘Creation verb’ here refers to what I have called ‘explicit’ creation verbs, in that the theme DP explicitly refers to the created object. This is in contrast with implicit creation verbs, where no DP argument refers to the created object. A minimal pair can be constructed as in (192):

- (192) a. She braided her hair. (implicit creation)
 b. She braided a necklace. (explicit creation)

One might argue that, structurally, these verbs are equivalent. After all, they seem to be derived from the same root. However, this does not seem to be correct, as there are syntactic contrasts between these types of verbs.

One contrast is again in terms of combination with applicatives. Explicit creation verbs allow for benefactive applicatives, while implicit creation verbs do not, as seen above:

(193) She braided Mary a necklace.

(194) * She braided Mary the strands (e.g., where the strands are made into a braided necklace).

The same contrast is found in Finnish¹:

- (195) a. * Hän leti-tti minu-lle minu-n tukka-ni.
 s/he braid-CAUS.PST 1SG-ALL 1SG-GEN hair-POSS1SG
 ‘She braided me my hair.’ (implicit creation reading)

¹According to Marcel den Dikken (p.c.), sentences like (195a) are possible in eastern Dutch with an inalienable possessee such as ‘the hair’. However, further research is necessary to determine whether the possessor in such cases is truly the argument of a low applicative head.

- b. Hän leti-tti minu-lle pullapitko-n.
 s/he braid-CAUS.PST 1SG-ALL braided.bread-ACC
 ‘She braided me a ‘braided bread’.’(explicit creation reading)

Thus it does not seem that the same structure should be extended to implicit creation verbs. This difference in structure predicts that explicit creation verbs should pattern differently from implicit creation verbs in other respects. An explanation for this syntactic contrast based on semantic type will be motivated in chapter 6.

Another way in which these verb classes differ is that explicit creation verbs allow for resultatives, where the explicit created object is modified by the resultative predicate. This can be seen from the fact that in Finnish, the canonical resultative case, translative, is possible on the modifying predicate when controlling for the explicit creation reading:

- (196) Mari leti-tt-i leti-n tiuka-ksi.
 Mari braid-CAUS-PAST braid-ACC tight-TRANS
 ‘Mari braided the braid tight.’

Norwegian similarly shows resultative morphology, in the shape of adjectival agreement, on such predicates with explicit creation verbs, whereas agreement was shown to be not possible with implicit creation verbs. Thus agreement morphology on the predicate disambiguates between the implicit and explicit creation verb readings:

- (197) a. Marit skjærte kaka tynn-Ø.
 Marit cut cake-DEF.F thin-M/F.SG
 ‘Marit cut the cake thin.’ (i.e., the entire cake is made thin)
- b. Marit skjærte kaka tyn-t.
 Marit cut cake-DEF.F thin-NEUT.SG
 ‘Marit cut the cake into thin slices.’

Default neuter agreement forces a pseudo-resultative interpretation, and thus also an implicit creation verb reading in (197b). Feminine agreement, on the other hand, gives a

resultative interpretation, and thus an explicit creation verb, as in (197a).

4.3 Implicit Creation Verbs vs. Source-Frame Paraphrases

In the previous sections it has been shown that implicit creation verbs have a different structure than inchoative verbs or explicit creation verbs; the root does not combine directly either with the direct object or the *v*. This brings us back to the semantic proposal that there is a locative, relational structure which mediates the relationship between the root and the theme object. The structure that was proposed for the semantic composition was one in which the root is in the role of ‘goal’ in a goal-frame structure, similar to the paraphrase in (198).

(198) She made her hair into a braid.

(198) is essentially a syntactically less conflated version of a sentence with an implicit creation verb, with an overt *into* instead of INTO and the same theme and goal arguments. With implicit creation verbs, the goal merges with *v*, but in (198), *v* is spelled out as *make* and the goal is realized as a DP argument. I will refer to the verb *make* in these contexts as *make_{goal}*, to emphasize the goal-frame structure that occurs with this interpretation of the verb *make*. These similarities predict further syntactic and morphological parallels between sentences with implicit creation verbs and those in (198), as opposed to other paraphrases such as in (199):

(199) She made a braid from her hair.

This use of *make* I will call *make_{source}*. Given the parallels suggested between the overt and covert structures, the former would predict parallel behavior between the implicit cre-

ation verb and such paraphrases, while the latter would predict behavior close to the latter. In this section I will argue that an analysis based on the goal-frame structure provides the best empirical coverage for implicit creation verbs.

4.3.1 Availability of Passive

The direct object of *make_{goal}* is able to undergo passivization. The argument which can take subject position is the theme of the goal relation, the material which is made into the created object. If the structure is the same for implicit creation verbs, the same argument is predicted to be able to undergo passivization as well. This is in fact possible, as opposed to failure of passivization of the relevant argument in the structure with the created individual as direct object:

- (200) a. **The string** was braided by Mary.
 b. **The string** was put/made into a braid by Mary.
- (201) a. ***The string** was made a braid out of by Mary.

This contrast can be explained by the fact that the argument ‘the string’ must cross the higher DP argument ‘a braid’ in the source relation structure, as in (202):

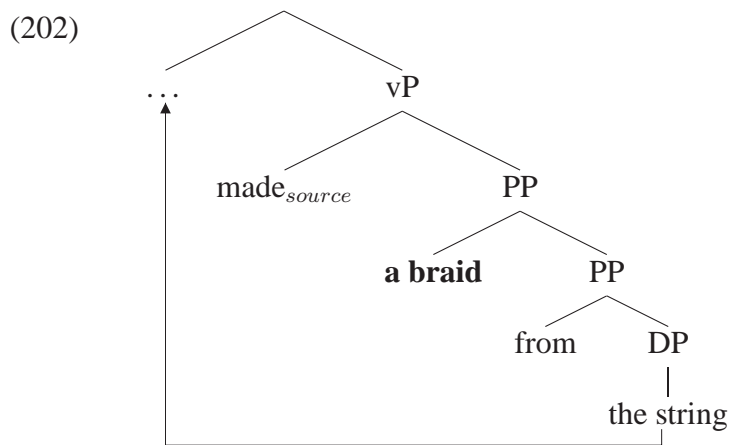

In contrast, in neither the structure of the implicit creation verb nor of the vP of *make_{goal}* would the theme have to pass over the other argument in the relational PP:

(203) a.

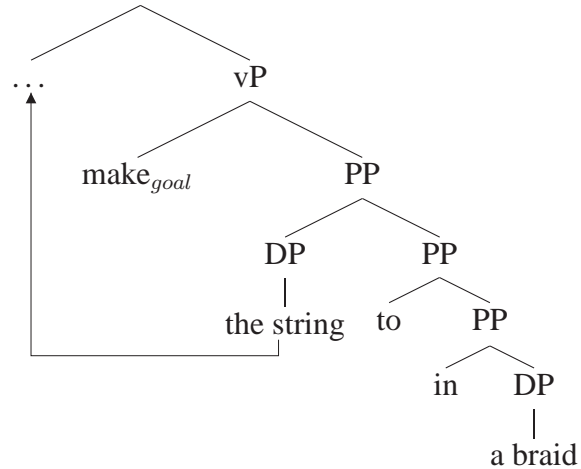

b.

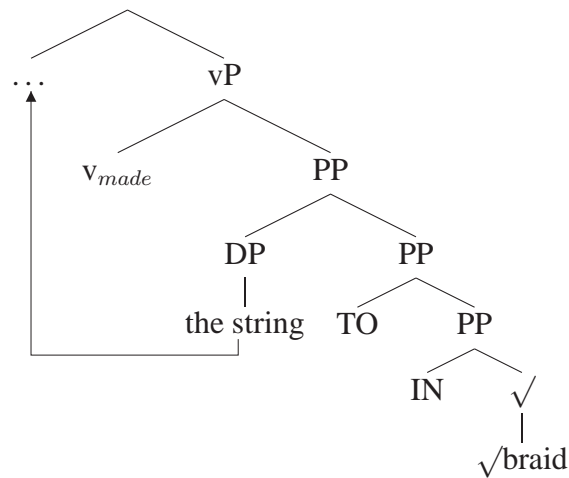

4.3.2 Unavailability of Low Applicative Arguments

As shown above, implicit creation verbs do not combine with applicative arguments in English. The same is found with *make_{goal}*, and the opposite with *make_{source}*, as predicted by the parallel structure between implicit creation verbs and the former.

(204) a. * I braided Mary the string. (where ‘string’ is the source, or object being braided)

b. * I made Mary the string into a braid.

(205) I made Mary a braid from her hair.

This contrast highlights a difference between *make_{goal}* and *make_{source}* that has not been mentioned thus far. That is that while *make_{goal}* takes an obligatory prepositional small clause argument containing two related arguments, *make_{source}* takes an obligatory theme argument and an optional source argument:

(206) I made_{goal} *(the string) *(into a braid).

(207) I made_{source} *(a braid) (from her hair).

It is the obligatory small clause complement with two obligatory arguments that seems to make *make_{goal}* incompatible with applicatives, as opposed to *make_{source}* which only has one obligatory DP argument. This can be attributed to the fact that the applicative head itself requires a small clause-like structure, as argued by Pylkkänen (2002). According to the analysis of the double object construction in English as in Pylkkänen (2002) (whereby recipient DPs are ‘low applicatives’), applicative phrases are merged in the usual position of the direct object, such as the position of *the book* in (209b). The low applicative head, APPL, takes three arguments: two individual arguments (type *e*) and then a function of type $\langle e, \langle s, t \rangle \rangle$, as in (210b). The full type of APPL is $\langle e, \langle e, \langle \langle e, \langle s, t \rangle \rangle, \langle e, t \rangle \rangle \rangle \rangle$, as expanded in (208) from Pylkkänen (2002:22).

(208) Low-APPL-TO (Recipient applicative):

$\lambda x. \lambda y. \lambda f_{\langle e, \langle s, t \rangle \rangle}. \lambda e. f(e, x) \ \& \ \text{theme}(e, x) \ \& \ \text{to-the-possession}(x, y)$

(209) a. I bought the book.

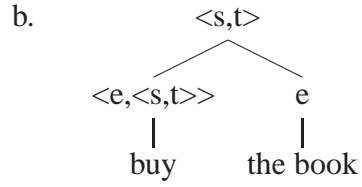

(210) a. I bought Mary the book.

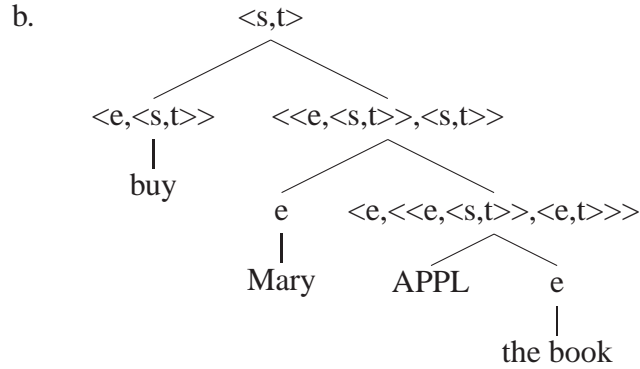

The APPL head establishes a possession relation between its DP arguments, such that the first argument comes to be in the possession of the second. The APPL head can easily combine with *make_{source}*:

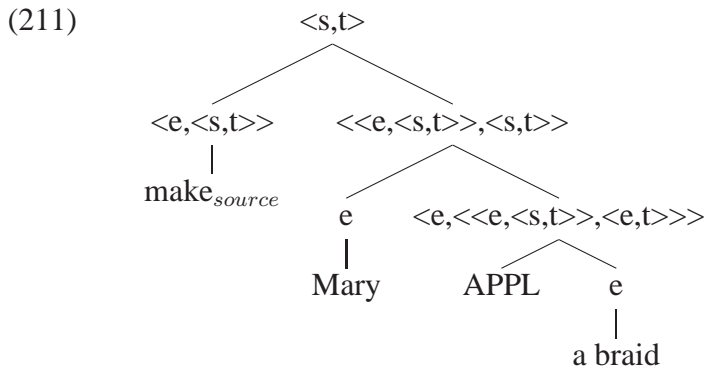

The only position that the APPL head could semantically compose for *make_{goal}* is as in (212b):

(212) a. * Susan made Mary her hair into a braid.

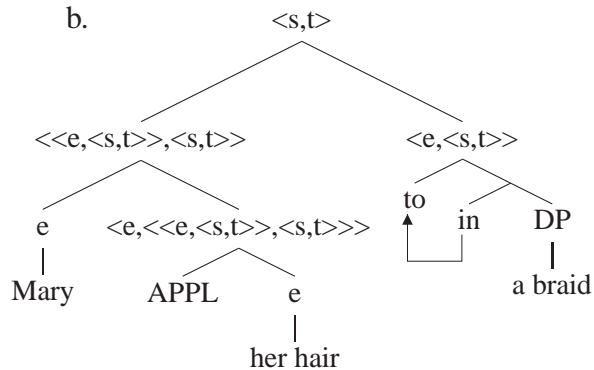

Similarly, the only position that the APPL head could semantically compose for implicit creation verbs is as in (213b):

(213) a. * Susan braided Mary her hair.

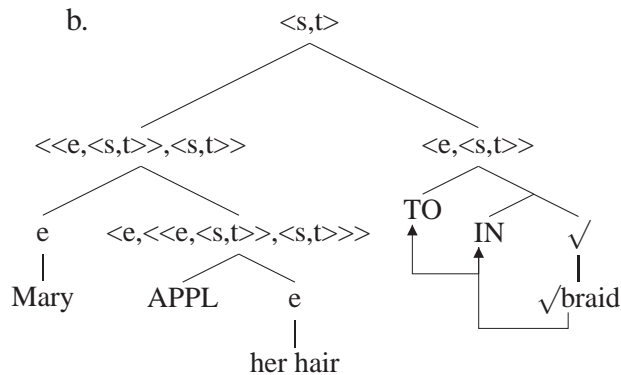

However, both of these sentences are semantically anomalous, because, given the semantics of APPL, they would have to entail that Susan transferred Mary's hair to Mary's possession by an event of making that hair into a braid. The transfer of possession of the **source** is not compatible with the interpretation of the event as changing the location to the first argument of the locative preposition. The entity that might plausibly be transferred is denoted by the root. However, this element cannot be an argument of the APPL head because it is of type $\langle e, t \rangle$, not e . Even if the root were of type e , merger of APPL

and a second ‘possessor’ argument would not give the right type element to then combine with the IN head. Thus the only way the APPL head could combine with an implicit creation verb would lead to a semantically anomalous interpretation, in contrast with explicit creation verbs where the root is a manner modifier.

4.3.3 Availability of Depictives

Depictive modification is another domain in which there is a contrast between sentences with $\text{make}_{\text{goal}}$ and implicit creation verbs on the one hand, and those with $\text{make}_{\text{source}}$ on the other. These are available as modifiers of the theme of the goal relation:

- (214) a. I braided her hair_i (tight) wet_i.
b. I made her hair_i into a braid wet_i.

However, they are not possible as modifiers of the source embedded in a PP:

- (215) * I made a braid out of her hair_i wet_i.

This is a general constraint on object depictives, that they cannot modify the objects of prepositional phrases (Pylkkänen 2002). Thus this provides further evidence that in implicit creation verbs, the relation between the root and the theme must not be one in which the theme is the object of a preposition. Otherwise, it would not be modifiable by object depictives².

²This assumes that null prepositions interact with depictives in the same way as overt prepositions. An alternative would be to assume that null prepositions do not block depictive modification, and thus the availability of object depictives with implicit creation verbs would not help distinguish between these hypotheses. It is an open empirical question whether the objects of null prepositions are generally available for depictive modification.

4.4 Implicit Creation Verbs and Locative Case

4.4.1 Finnish Illative Case

As shown in section 3.1.2.1.1, Finnish pseudo-resultatives are marked with illative case. This illative case marking relates in this and other contexts to the INTO head proposed in the structure of implicit creation verbs. In the Finnish parallel to a sentence with *make_{goal}*, the created object and its modifier are also marked with illative case, just as the English example has an overt instance of the preposition *into*, as seen in (216):

- (216) a. Mari leti-tt-i hiukse-nsa tiukka-**an**.
Mari braid-CAUS-PAST hair-ACC.POSS tight-ILL
'Mari braided her hair tight.'
- b. Mari pisti hiukse-nsa (tiukka-**an**) letti-**in**.
Mari put hair-ACC.POSS (tight-ILL) braid-ILL
'Mari put her hair into a tight braid.'

The illative case marked on the pseudo-resultative predicate would follow if, as proposed, there is a locative structure similar to that in (216b) embedded in the implicit creation verb. The proposal is that there is a head within this structure that assigns case to the goal argument, namely the head identified as TO in chapter 2³. Even when the head is not conflated into the verb it is null in Finnish. In current minimalist theory, the mechanism for case-assignment is Agree (Chomsky 1995, 2000, 2001a). Agree is an operation which establishes a relation between a lexical item and a matching feature within a restricted domain, as discussed for adjective concord in chapter 3. Matching is defined

³The case assigned by the TO head must be somehow influenced by the lower preposition, IN, since the realization of illative case is dependent on both the properties of the localizer and the modalizer. If the localizer were equivalent to English *on*, rather than *in*, the case realized would be allative. I do not at present have a formal syntactic account for this type of compositional case assignment.

as a relation established by feature identity between a probe (such as ν) and a goal (such as the object). The domain is defined as the sister of the probe, and locality as “closest c-command”. So, a matching pair will agree if the goal is in the sister of the probe and there is no intervening match. A probe will not be able to Agree with a goal across another matching probe. Thus, structural objective case essentially reduces to object agreement, i.e., matching of φ -features between the probe ν and the DP object results in an Agree relation which also deletes the uninterpretable structural case on the DP. A sketch of this is given in (217):

(217) Agree

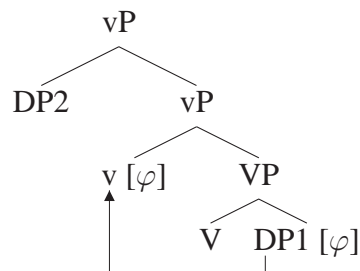

In this diagram, the arrow represents an Agree relation, rather than a movement. Because of the Agree relation, DP1 will be assigned structural case.

In the structures relevant here, the case assignment is not done by the ν , as ν must assign accusative case to the theme argument. Rather it is one of the relational heads that must assign the case. When the goal is realized as a DP, all elements in that DP will exhibit illative case, as in (216b), assuming the Agree relation in (218):

(218)

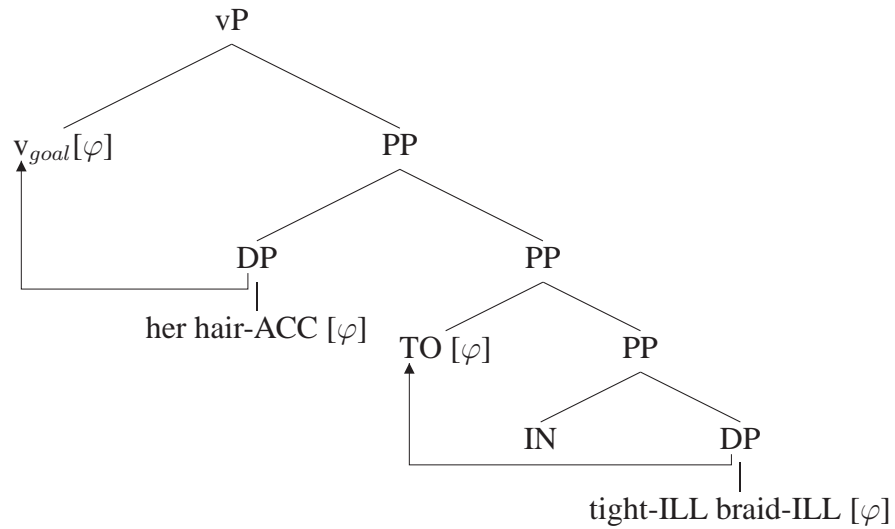

In the case where the goal is realized by the root, the TO element may agree with the pseudo-resultative AP instead. In Finnish, APs can stand alone as case-marked elements as seen extensively in the data presented here, in contrast with the inability of APs to be the complements of prepositions in English. This case marking must be in some sense optional, since the pseudo-resultative predicate is not an obligatory element, and thus there may be no constituent with overt illative case with implicit creation verbs. The Agree relation would proceed as in (219):

(219)

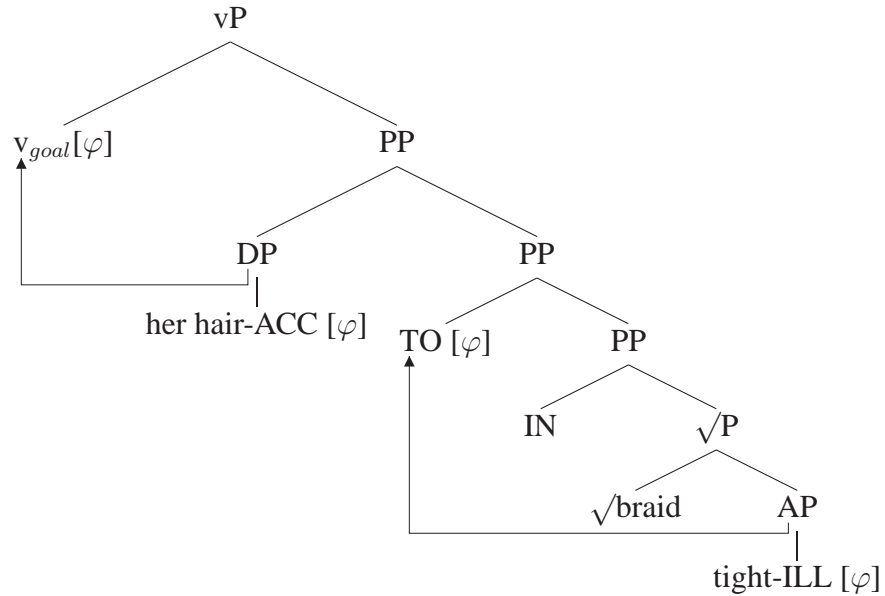

The presence of this case marking supports the syntactic presence of the locative relational heads proposed for semantic reasons in chapter 2.

4.5 Summary

In this chapter, it was argued that the root of implicit creation verbs is syntactically merged in a structure reflecting the semantic structure proposed in chapter 2. Despite the fact that the root is of the same syntactic category as the roots of inchoative and explicit creation verbs, its syntactic context is different. It will be shown in chapter 6 that this is ultimately due to a difference in semantic types, rather than syntactic category.

Chapter 5

Japanese Bracketing Paradoxes

In chapter 3, it was argued that pseudo-resultative predicates are root-modifying APs. In this chapter, it will be shown that this analysis of pseudo-resultatives can be fruitfully extended to account for the modification found in a certain kind of “bracketing paradox” in Japanese. In these environments, the pseudo-resultative appears to have the status of a head within a compound, rather than as a phrasal constituent. The unification of these bracketing paradoxes with pseudo-resultative modification brings us one step closer to understanding the semantic restrictions found in both environments. Further, the range of possible roots for implicit creation verbs in Japanese shows that even roots which may intuitively seem to denote predicates of states can be predicates of individuals, as evidenced by the possibility pseudo-resultative modification.

5.1 Introduction

Kitagawa (1986) introduced into the literature a set of apparent “bracketing paradoxes” from Japanese, in which the necessary semantic bracketing does not seem to map directly to the linear surface string. This is another instantiation of the kind of morphological

bracketing paradoxes discussed in Pesetsky (1985). Asano (2004) presents a morphological account for these paradoxes in the framework of Distributed Morphology (Halle and Marantz 1993), which makes use of the operation of Local Dislocation (Embick and Noyer 2001, Embick 2006). In this chapter, I explore an alternative account that makes use of Local Dislocation, but assumes a different syntactic structure that better accounts for the semantic composition and restrictions. I then discuss in the last section further data which require an extension of the analysis to account for the lack of compounds in passive and unaccusative structures.

5.2 Japanese Bracketing Paradoxes

The examples introduced by Kitagawa (1986) are as in (220) (Kitagawa 1986:ex.2)¹:

- (220) a. ko-goshi-o kagameru
little-waist-ACC bend
'slightly bend oneself'
- b. usu-me-o akeru
little-eyes-ACC open
'open one's eyes slightly'
- c. oo-guchi-o akeru
big-mouth-ACC open
'open one's mouth wide'
- d. ko-waki-ni kakaeru
little-armpit-LOC hold
'lightly hold something under one's armpit'

¹The orthographic conventions used are those found in Asano (2004), for the sake of consistency with later examples.

In these phrases, there is an adjectival constituent, such as *ko*, ‘little’, in (220a), which is affixed to a nominal element, such as *goshi*, ‘waist’.

Japanese has widespread compounding of various types. The relevant type here is ‘Adjective-Noun’, or ‘A-N’. According to Kageyama (1982), some of the ‘adjectival prefixes’ are as in (221):

- (221) dai-, oo- ‘big’, tyuu- ‘middle’, syoo-, ko- ‘small’, koo- ‘high’, tei- ‘low’, sin-
 ‘new’, ko-, huru- ‘old’, zyuu- ‘heavy’, kei- ‘light’, tyoo- ‘long’, tan- ‘short’,
 kyuu- ‘sudden’, bi- ‘beautiful’, aku- ‘bad’, koo- ‘good’

Although they are described as prefixes, it seems that these form a limited class of adjectival roots which can not only receive adjective or adverb inflection, but also participate in A-N compounding. These adjectival stems can be affixed to nouns and semantically function as modifiers of that noun:

- (222) naga-isu
 long-chair
 ‘long chair’

The compounding adjective itself is a simplex morpheme, but the A-N compound can be further modified by other adjectives bearing adjective inflection, such as the suffix *-i*:

- (223) aka-i naga-isu
 red-A long-chair
 ‘long red chair’

The position of the adjective stems in (220) would be ambiguous between an adverbial reading and adjectival modification of the noun it is affixed to, if it weren’t for the fact that these adjectives are not able to modify these nouns in other compounding environments. Note the following data from Kitagawa (1986) and Kindaichi (1973) via Asano (2004),

showing that the compounds found in bracketing paradoxes are not acceptable in other environments:

- (224) a. * aitsu-no usu-me
that-guy-poss thin-eyes
'that guy's thin eyes'
- b. * obaachan-no ko-goshi
grandma poss little-waist
'grandma's little waist'
- c. * kanozyo-no ko-waki
she-POSS little-armpit
'her little armpit'
- d. * boku-no oo-guchi
I-POSS big-mouth
'my big mouth'

Thus the evidence shows that these adjectives are not modifying the noun that they are attached to in the bracketing paradox examples.

That compounds are in fact morphological words is argued by Kitagawa (1986) on account of the fact that they undergo the process of *rendaku*, taken to be a word-level process in Japanese. *Rendaku* is seen in cases such as (225b), where the 'mouth', underlyingly 'kuchi' as seen in (225a), is realized as 'guchi' due to the affixation of *oo-*:

- (225) a. oo-ki-ku kuchi-o akeru
big-ki-ADV mouth-ACC open
'open one's mouth widely'
- b. oo-guchi-o akeru
big-mouth-ACC open
'open one's mouth wide'

The adjectival element has been argued to receive an adverbial interpretation, such that in (226a), *usu-* is interpreted as a VP-level event modifier². The conflicting morphological and semantic structures given by Kitagawa are given in (226):

- (226) a. *usu-me-o akeru*
 little-eyes-ACC open
 ‘open one’s eyes slightly’

b. PF Input:

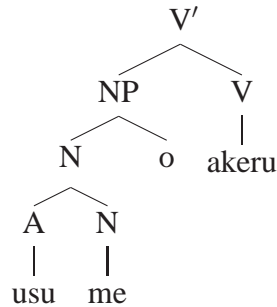

c. LF Input:

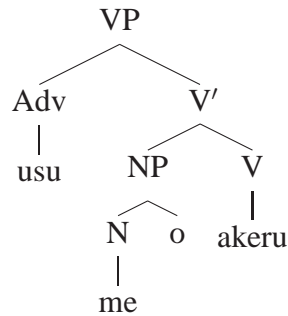

The parallelism between the compounding adjective and adverbs seems to be supported by the availability of sentences with the same adjectives bearing adverbial inflection which have a similar meaning (*chiisa* in (227a) is the pronunciation of the same character as *ko-* in non-compounding contexts):

- (227) a. *chiisa-ku koshi-o kageru*
 little-ADV waist-ACC bend
 ‘slightly bend oneself’

²Kitagawa (1986) assumes that adverbial event modifiers are generally in VP specifier positions.

- b. usu-ku me-o akeru
thin-ADV eyes-ACC open
'open one's eyes slightly'
- c. oo-ki-ku kuchi-o akeru
big-ki-ADV mouth-ACC open
'open one's mouth wide'

Kitagawa (1986) argues that the bracketing paradox is a result of an LF movement producing the semantic structure in (226c) from the syntactic structure as in (226b). As will be outlined in the next section, Asano (2004) argues against this approach and for an account in which the interpreted syntactic structure is different than that proposed by Kitagawa (1986) and the paradox results from the morphological operation of Local Dislocation.

5.3 Asano's 2004 Proposal

Asano (2004) presents several arguments against Kitagawa's (1986) approach which will not be repeated here. She argues instead that the position of the adjectival element is in a lower verb-modifying position in the syntax, as in in (228b):

- (228) a. oo-guchi-o akeru
big-mouth-ACC open
'open one's mouth wide'

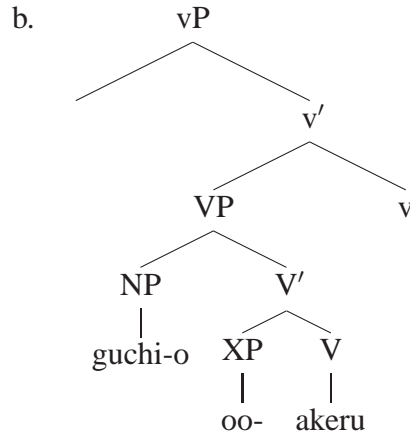

Asano argues that the adjectival element is an AP³ which receives an adverbial interpretation and is a modifier in complement position of the verb. The internal argument of the verb is merged as the specifier of the lexical verb. Asano's treatment of the adjectival element as 'adverbial' is due to the fact that the modifier seems to modify the verb, rather than the nominal element it is affixed to. However, no details of the interpretation of the adverbial element are given. The semantic status of this element will be returned to in the next section.

Asano proposes that the surface order is subsequently derived by the morphological operation Local Dislocation proposed by Embick and Noyer (2001) (cited as an earlier working papers version of the same paper, Embick and Noyer (1999)). Local Dislocation is an operation which takes place after syntax, and after Vocabulary Insertion (assuming Late (post-syntactic) Insertion). Because Local Dislocation takes place after Vocabulary Insertion, it is an operation that is expected to be sensitive to properties of specific Vocabulary Items. Embick and Noyer further hypothesize that linearization takes place at Vocabulary Insertion, and thus Local Dislocation (henceforth 'LD') takes place after the

³Asano does not present evidence specifically for the phrasal status of this element, but presumably analyzes it as such since it is in the complement position of the verb, a phrasal position. However, no other material may be present in the AP in these examples.

syntactic structure has been linearized. It is not an operation over syntactic structures, but over linear adjacency. Representing linear adjacency with a ‘*’, the linearization of (229) could be represented as in (230):

$$(229) \quad [_{XP} X [_{YP} [_{ZP} Z] Y]]$$

$$(230) \quad [X * [Z * Y]]$$

LD may rearrange linearly adjacent items via affixation (represented by ‘+’) as in (231)⁴:

$$(231) \quad [[_{Z^0} Z + X] * Y]$$

For the cases under consideration, Asano (2004) proposes that the linearization in (232) leads to the output of LD in (233):

$$(232) \quad [[_N \text{guchi}] * [_A \text{oo-}] * \text{akeru}]$$

$$(233) \quad [[_N] * \underbrace{[_A \text{oo} + \text{guchi}]} * \text{akeru}]$$

The motivation for this LD operation is a revised version of the Stray Affix filter as in (235):

(234) Stray Affix Filter (Baker 1988): *X if X is a lexical item whose morphological subcategorization frame is not satisfied at S-structure.

(235) Revised Stray Affix Filter (Asano 2004): *X if X is a lexical item whose morphological subcategorization frame is not satisfied in its surface realization.

The Revised Stray Affix Filter motivates LD in the relevant cases because the adjectival element is a bound morpheme, and needs a host for affixation. The linearly adjacent noun provides such a host.

⁴Local Dislocation is also intended to effect string-vacuous re-bracketing, which I will not go into here.

In the next section, I will show that the adjectival element can be treated as a root-modifier, rather than as an adverb, without losing the desirable consequences of Asano's analysis. Unifying these modifiers with pseudo-resultatives provides insight into the lexical restrictions found in both environments.

5.4 A as a Root Modifier

In the previous sections, it was shown that Asano's (2004) morphological account for these Japanese bracketing paradoxes combined with phase-based spell-out is able to account for some of this 'paradoxical' data. However, in this section I will argue that the underlying structure is not exactly that which Asano has proposed and modify the account accordingly.

The productivity of these bracketing paradoxes is not directly addressed in the literature. However, it appears to be very limited. Aside from apparent morphological constraints on A-N combinations, it seems that all of these examples share a semantic property - namely that the adjectival morpheme can be interpreted as modifying an individual denoted by the root of the verb which is created as a result of the event. That is, all of these verbs can be interpreted as implicit creation verbs, and the modifiers as pseudo-resultative predicates. Although the Japanese construction does not seem to be very productive, (236) with the implicit creation verb 'braid' is also possible for some speakers:

- (236) % Mary-ga kata-gami-o yu-u.
Mary-NOM tight-hair-ACC braid
'Mary braided the hair tight.'

Asano marks the node above *akeru*, 'open', as V, but no argument is given for the

status of this element as a verb rather than as a root. Although inchoative or causative-inchoative verbs like *open* are standardly considered to be derived from predicates of states, what can be seen from the examples with *akeru* is that in Japanese the relevant root, $\sqrt{\text{ak}}$, can also denote a predicate of individuals. As discussed in Volpe (2005), the transitive verb *ak-e-ru* is related to the intransitive variant, *ak-u*. *-ru* is the non-past marker for vowel-final stems. When the root is realized as a predicate of individuals, it will form part of an implicit creation verb, and pseudo-resultative modification will be possible. In such an environment, the root will have a meaning similar to ‘opening’, such as in ‘wide opening’. When the root is realized as a predicate of states, it will form part of an inchoative verb, and pseudo-resultative modification will not be possible.

If the same arguments for pseudo-resultative predicates can be extended to these Japanese cases, as is plausible considering their semantic relatedness, then these adjectival predicates should be analyzed in the same way, with the adjective modifying a root denoting a predicate of individuals, rather than a verb.

Like the cases from Japanese, some pseudo-resultative predicates can be realized in some contexts with adverb morphology. However, they are not predicates of events, as a modifier of the verb would be. Rather, they modify an individual created by the event. This gives a non-accidental account for their ability to appear with adjective morphology, if the category being modified can be modified by adjectives.

The proposal made for pseudo-resultatives as APs in languages like English and Finnish is repeated in (237):

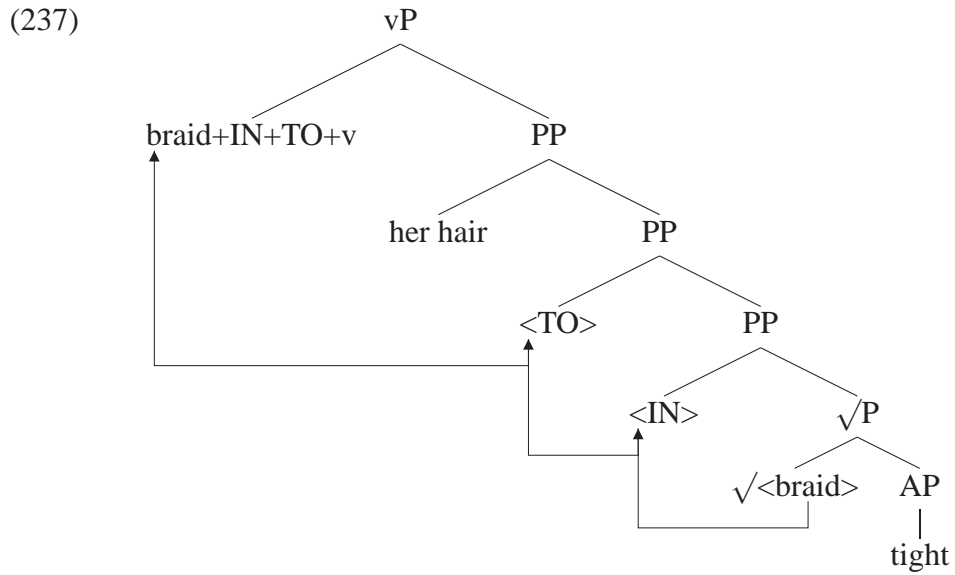

Extending this structure to Japanese would give (238):

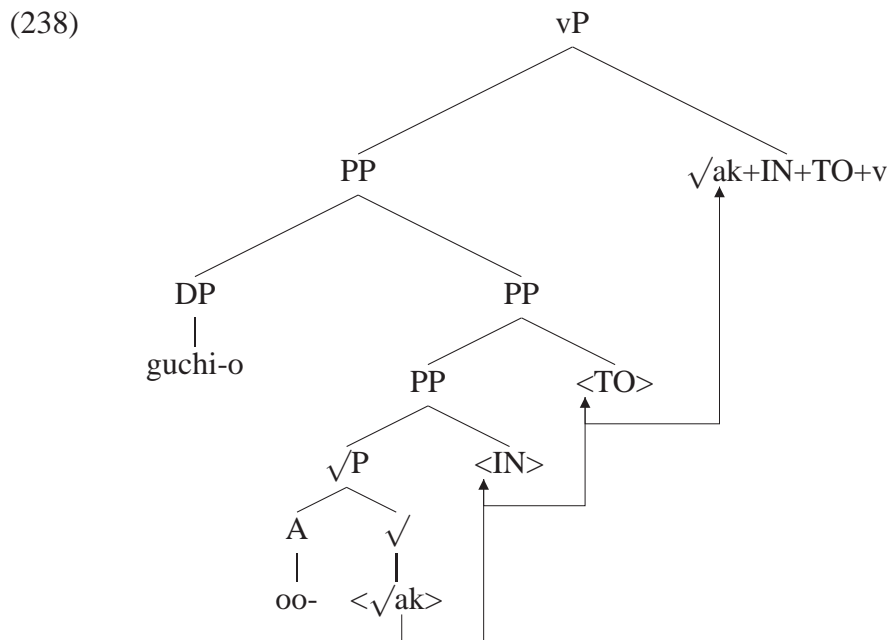

The predictions for LD are the same for this structure as for that proposed by Asano, as the adjectival morpheme remains linearly adjacent to the direct object.

The semantic composition would proceed in the same manner as proposed for implicit

creation verbs in English in chapter 2, with the types as in (239):

(239)

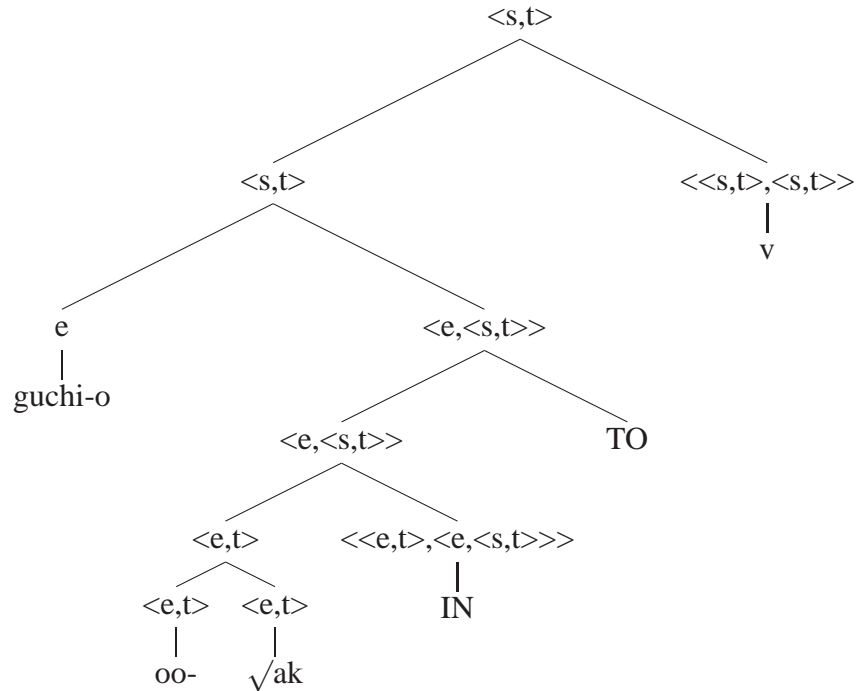

In this section, I have shown that the Local Dislocation account proposed by Asano (2004) can be adapted to better account for the semantic composition and the restrictions on the modifier-verb pairs, which are reminiscent of pseudo-resultative modification in English.

5.5 Extending Asano's 2004 Account

5.5.1 Unaccusatives and Passives

Asano (2004) discusses various predictions of the Local Dislocation approach to these bracketing paradoxes, but does not explore the potential consequences for argument structure alternations. Her analysis as presented, and the modification of it that I have proposed thus far, predicts that the same A-N spell-outs should be available even when the internal

argument has been promoted to a higher position, either in an unaccusative structure or in the passive. However, this prediction is not borne out. Although the relevant adverbs are possible with unaccusatives and passives as shown in (240a) and (241a), (240b) and (241b) show that the A-N compounds are not:

- (240) a. (Usu-ku) me-ga (usu-ku) aku.
 (thin-ADV) eyes-NOM (thin-ADV) open
 ‘The eyes open slightly.’
- b. *Usu-me-ga aku.
 thin-eyes-NOM open
 ‘The eyes open slightly.’
- (241) a. John-no kuchi-ga ooki-ku (Mary-ni-yotte) aker-are-ta.
 John-GEN mouth-NOM big-ADV (Mary-by) open-PASS-PST
 ‘John’s mouth was opened widely (by Mary).’
- b. *Oo-guchi-ga (Mary-ni-yotte) aker-are-ta.
 big-mouth-NOM (Mary-by) open-PASS-PST
 ‘The mouth was opened wide (by Mary).’

The adjectival element only attaches to the argument in object position. Although Asano’s theory does not directly predict these contrasts, if we add the assumptions that spell-out is cyclic, or phase-by-phase, that movement to the edge of a phase is necessary to move out of a phase (Chomsky 2000, 2001a,b), and that *vP* is a phase (Legate 2003, Marantz 2006), then these facts could be accounted for within the Local Dislocation account.

On the formulation of phases in Chomsky (2000, 2001a,b), the domain of a phase head is ‘sent off’ for spell-out (to PF) and interpretation (to LF), while the head itself and its specifier(s) are accessible for further syntactic operations. If *vP* is a phase (as proposed by Chomsky at least for transitive *vPs*, and for all *vPs* by Legate (2003) and Marantz (2006)), then promotion of the internal argument to a position outside of the phase will require that argument to first move to the edge of *vP* before moving on to a

higher position. Thus in order to derive unaccusative and passive sentences, the internal argument must move to the edge of the phase. The structure at spell-out for the cases under consideration is represented in (242):

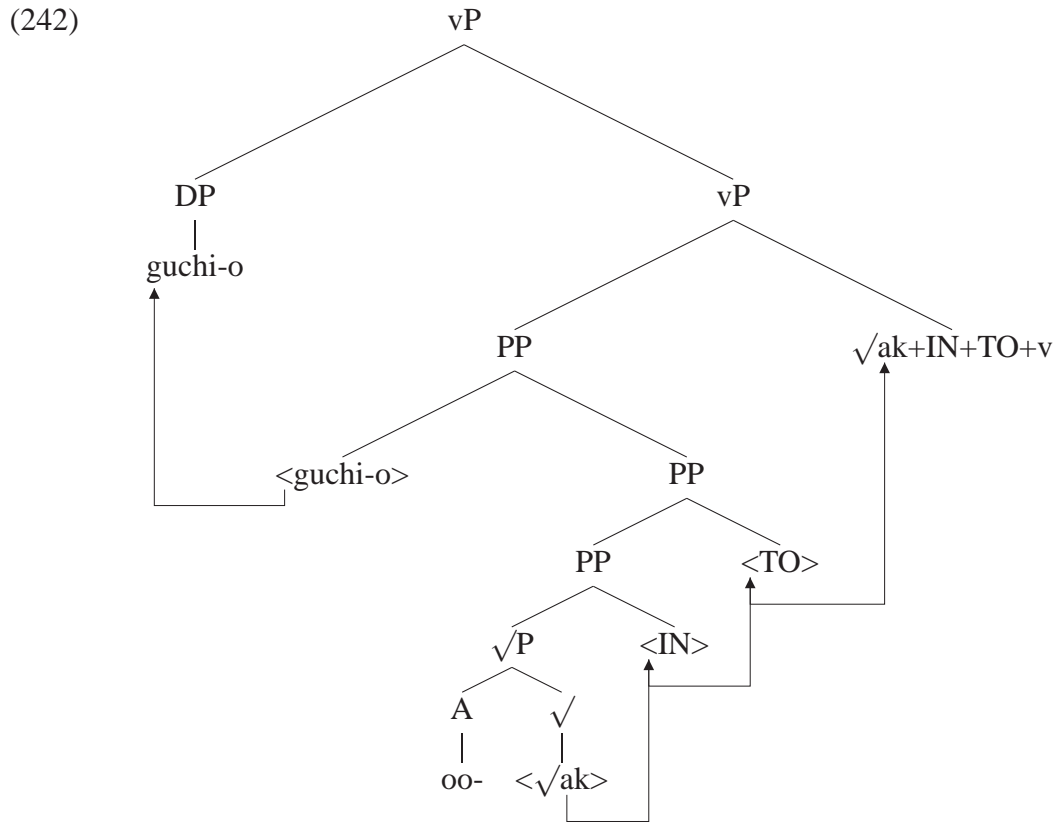

If the constituent for spell-out is the domain of the phase head, then only elements contained in the vP will be spelled out at this phase. Since the internal argument is at the edge, then it will not be spelled out in the same cycle as the adjectival morpheme, and will thus not be available for Local Dislocation to the right of that morpheme. Note that such an account depends upon the phasehood of unaccusative and passive vPs.

However, this account raises a further question - why would the derivation crash in such a case? That is, why is the following not possible?

- (243) guchi-o oo-akeru
 mouth-ACC big-open

‘open one’s mouth wide’

There seems to still be another element which is available for the adjectival element to affix to, namely the verb itself. The fact that this compounding is unavailable can also be accounted for by making reference to phase-based spell-out, if the verb is assumed to move to a node higher than *v*, such as *T*. If such movement must occur, then *v* must also move to the phase edge before spell-out, and will thus also be unavailable for affixation of the adjectival element. The only element left in the VP would be the A itself:

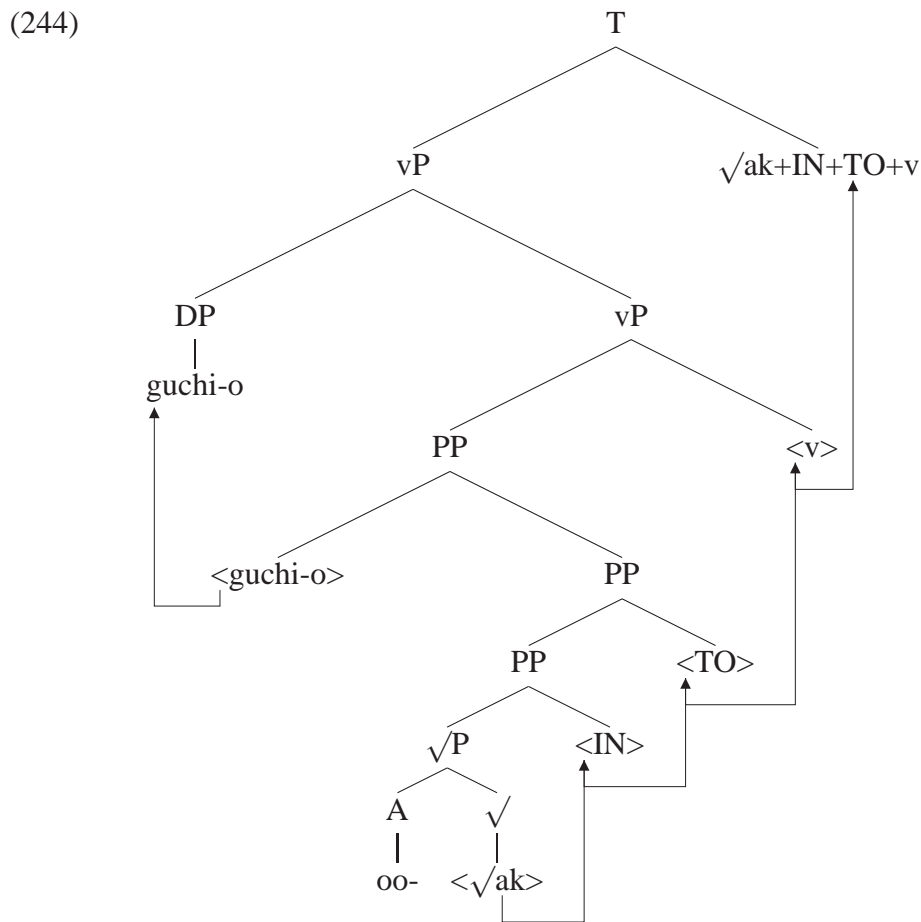

In order for this account to go through, one must also assume that the affix cannot attach to the verb before it moves to the phase edge, such that it is pied-piped. This is a question

regarding the constraints on compounding which must be explored further in future work.⁵

5.5.2 Status of the Case Marker

Another issue which Asano (2004) does not address (except to footnote as an issue for further investigation) is the relevance of the case marker, usually accusative *-o*, found on the object in these sentences. The noun is only linearly adjacent to the adjectival element if it is taken to form one complex element which includes the case marker; otherwise, it would only be the case marker that is adjacent to the adjectival element.

The fact that it is the noun plus the case marker that is relevant for LD provides support for Embick and Noyer's (2001) proposed distinction between 'M-words' (or 'Mwds') and 'Subwords', given here as presented later in Embick (2006):

- (245) M-Word: (Potentially complex) head not dominated by further head-projection (cf. Chomsky (1995) " H^{0max} ")
- (246) Subword: Terminal node within an M-Word (i.e. either a Root or a feature bundle)

Embick (2006) adds the following 'Typing Assumption' regarding LD operations (informally introduced in Embick and Noyer (2001)), motivated by the 'Sufficient Ordering Hypothesis':

- (247) Typing Assumption on Local Dislocation: M-Words only dislocate with adjacent M-Words, and Subwords with Subwords.

⁵This account cannot be the whole story, because the modifier does not seem to affix to other VP-internal material either. There must therefore be further restrictions on the possible host sites for the 'stray' affix.

(248) Sufficient Ordering Hypothesis: Linearization concatenates M-Words, and Subwords within M-Words. This suffices to order the phrase-marker. There are no concatenation statements between Subwords that are contained in different M-Words.

If the case marker on the noun is a dissociated morpheme, affixed to the noun by a post-syntactic morphological operation, then at the stage at which LD applies, this forms an M-word. It is thus consistent with this typing assumption that it is the whole M-word which inverts with the adjectival element, which is also an M-word.

5.6 Conclusion

In this chapter, I have shown that analyzing the modifiers in such structures as on a par with pseudo-resultative predicates allows for an account for the semantic restrictedness of the construction while preserving the positive results of the Local Dislocation account. Some questions for further research are (1) whether there is independent evidence for treatment of the relevant Japanese verbs on a par with implicit creation verbs in other languages such as English and Finnish, (2) why the bound adjectival morpheme cannot be supported by adjectival inflection, and (3) why in Japanese such adjectival modification seems to be limited to unmodified heads (at least in these cases), while in English more complex phrasal modifiers are possible.

Chapter 6

Consequences and Conclusions

6.1 The Ontology of Roots

It was argued in chapter 4 that there are structural contrasts between different classes of verbs which are all derived from category-neutral roots. However, if these roots are of the same syntactic category (root), then there must be an alternative explanation for the restrictions on their structural contexts. My proposal is that these constraints are actually due to the argument structure of the roots. That is, the semantic type of the root, which determines the arguments it combines with and the combinatorial possibilities in semantic composition, has syntactic ramifications. This proposal puts the onus of certain linguistic contrasts on the root itself, which is in opposition to the position held by Borer (2005a) that roots do not have grammatical properties of this type. However, it seems that cross-linguistic contrasts motivate the storage of some ‘arbitrary’ linguistic specifications for roots, including root type. That is, what appears to be the same root conceptually may vary across languages with respect to verb class membership, which would not follow if roots represented only universal conceptual information.

The contrasts cited in chapter 4 which must be explained are summarized in Table 6.1:

Verb Class	Unaccusative	Resultative	Pseudo-Resultative	Applicative
Implicit Creation Verbs	*	*	✓	*
Explicit Creation Verbs	*	✓	*	✓
Inchoative Verbs	✓	✓	*	✓

Table 6.1: Verb Class Patterns

These contrasts are argued to be due to the following contrasts between the root types involved in the derivation of these verb classes:

Verb Class	Root Type
Implicit Creation Verbs	<e,t>
Explicit Creation Verbs	<s _e ,t>
Inchoative Verbs	<e, <s _s ,t>>

Table 6.2: Root Types and Verb Classes

This is not meant to be an exhaustive list of root types or verb classes. However, it will be shown how these contrasts can be derived from the root types below.

6.1.1 Verbs Derived from Predicates of Events

As discussed in chapter 4, explicit creation verbs are those such as in (249):

(249) She braided a necklace.

While *braid* as an implicit creation verb relates the object DP to a created individual denoted by the root, *braid* as an explicit creation verb expresses no such relation. Rather, the object DP expresses the created object and the root contributes a manner specification for the creation of that object, such that this *braid* can be paraphrased as *braid* in (250):

(250) She made a necklace by braiding.

As summarized in Table 6.1, explicit creation verbs do not have unaccusative variants, occur with resultative predicates, do not occur with pseudo-resultative predicates, and do occur with applicative arguments. Assuming an analysis of explicit creation verbs as in Marantz (2005), the explicit creation verb variant of *braid* would have the structure in (251):

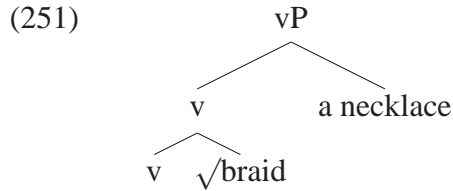

There are two ways to provide a compositional analysis for this structure containing the root $\sqrt{\text{braid}}$. One approach would be to expand the inventory of v heads such that the v in (251) is able to somehow compose with the root as an element of type $\langle e, t \rangle$. This would predict that roots with the type $\langle e, t \rangle$ can generally occur in explicit creation verb contexts. The alternative which I propose is that the inventory of v heads is not expanded in this way, but that the v in (251) is parallel to the overt verb *make_{source}*. I will label this head v_{source} . What is necessary instead of a more complex v head which composes with a root of type $\langle e, t \rangle$ is a root of a different type: $\langle s_e, t \rangle$. This means that the root $\sqrt{\text{braid}}$ can be either of type $\langle e, t \rangle$ or $\langle s_e, t \rangle$. However, the proposal is not that there is homophony between two roots, but that one root is able to have more than one associated denotation. This would be parallel to the ability of one root to have multiple allomorphs. As with allomorphy, it is language specific what denotations are associated with which roots. Thus in English, $\sqrt{\text{braid}}$ can denote either a predicate of type $\langle e, t \rangle$, or of $\langle s_e, t \rangle$, while in another language, only one of these denotations might be available. The available denotations would determine the possible environments for insertion of the root.

This approach seems to be empirically more desirable than the approach which embeds a predicate of type $\langle e,t \rangle$ under a more complex v type, for at least two reasons. One is that it does not appear that all roots of type $\langle e,t \rangle$, such as those which form implicit creation verbs, easily occur in explicit creation verb contexts. For example, a sentence with the root $\sqrt{\text{pile}}$ inserted in an explicit creation context is not felicitous¹:

(252) * She piled a stack of books.

The realization of the root in this type of structure is related to its possible denotations. The proposal is that such roots denote predicates of events (of type $\langle s_e,t \rangle$), and this is able to combine with the relevant v heads directly, rather than in a relational structure. I represent the relevant v head as v_{source} , aligning it with $make_{source}$. V_{source} must be of $\langle e,\langle s_e,t \rangle \rangle$. Since it takes a DP complement, and thus requires an individual argument. This v_{source} and the event-predicate root $\sqrt{\text{braid}}$ can combine via event identification (Kratzer 1996), as in (253):

(253) $\lambda x_e.\lambda e_s.\text{making}(e) \ \& \ \text{braiding}(e) \ \& \ \text{theme}(e,x)$

¹Interestingly, the addition of an applicative argument seems to improve the root's acceptability in the explicit creation verb context:

(1) ? She piled him a stack of books.

It may be that the applicative induces a coercion of the type of the root. This coercion may lead to the slight degradedness of this example. No degradedness would be expected if the root had a straightforwardly available $\langle s_e,t \rangle$ denotation, or if there were a v head available which could combine with the root as type $\langle e,t \rangle$.

Although this mode of composition is different from that by which predicates of events combine with manner adverbs, the result is equivalent, in that both the root and v_{source} come to take the same event as an argument. The difference is that here the resulting expression has an open individual argument slot. That this argument slot is introduced by the v head, not the root itself, is another desirable property of this analysis. Given that roots of explicit creation verbs do not take individual arguments, it is correctly predicted that such roots should be possible in intransitive contexts. This prediction appears to be borne out, as can be seen from the examples in (254) which contain verbs based on the same roots as explicit creation verbs:

- (254) a. The chef baked all day.
 b. The workers were building for days.

This is in contrast with implicit creation verbs, which are obligatorily transitive, as discussed in chapter 3. This contrast is another which can be explained by contrasts in root type.

This complex head can then semantically compose with the DP of type e as in (255):

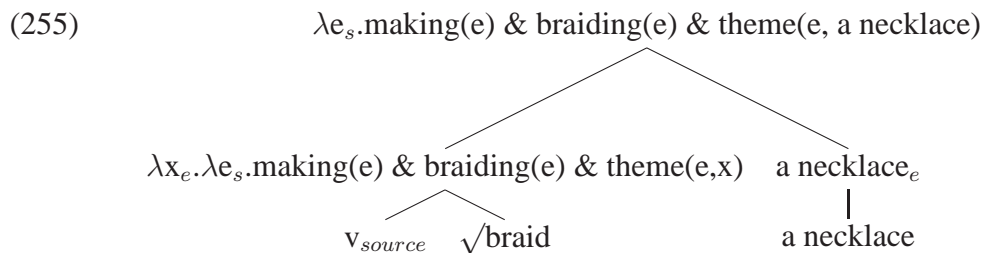

The correlation of the root type $\langle s_e, t \rangle$ with the structure in (255) is what ultimately leads to the generalizations cited above. The root type itself is what determines the fact that pseudo-resultative predicates are not possible; there is no element in the derivation of the verb with the appropriate $\langle e, t \rangle$ denotation for the pseudo-resultative predicate to combine with. The fact that such verbs do not have unaccusative variants can be explained

by the fact that the roots do not introduce a state argument that can combine with an inchoative v head.

The fact that these verbs can occur with applicative arguments is expected, given that there is a direct object of type e which combines with a complex v head of type $\langle e, \langle s, t \rangle \rangle$. The combination of the applicative head with this structure would be as in (256):

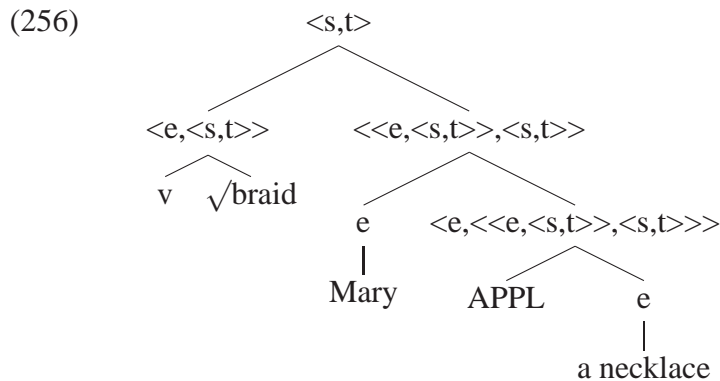

This is in contrast with verbs derived from predicates of individuals, such as implicit creation verbs, which do not accommodate an APPL head. In general, the prediction is that low applicative heads and pseudo-resultatives are in complementary distribution; the latter require a root of type $\langle e, t \rangle$, while the former are not compatible with such a root type.

6.1.2 Verbs Derived from Predicates of States

One class of verbs that is fairly universally considered to be semantically derived from states is that of inchoative (change-of-state) verbs, as in (257):

- (257) a. The door opened. (inchoative/anti-causative)
 b. Mary opened the door. (causative-inchoative)

(257a) is an example of an inchoative, and (257b), where an additional causative relation is introduced, a causative-inchoative. The structure proposed for the inchoative variants by Harley (1995) is repeated in (258):

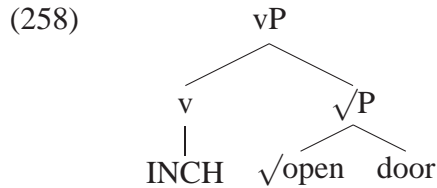

The root can occur in such a structure because it has an argument structure such that it combines first with a type e argument, and then a state argument. That is, it is of type $\langle e, \langle s_s, t \rangle \rangle$. This is in contrast with the roots of implicit or explicit creation verbs, which can only take arguments indirectly via a relational structure or an argument-taking v head. Therefore, the type of v that roots of type $\langle e, \langle s_s, t \rangle \rangle$ combine with will be different than that which combines with these other roots. The fact that the unaccusative variants are possible can be explained by the fact that the inchoative v head requires a state argument in its complement.

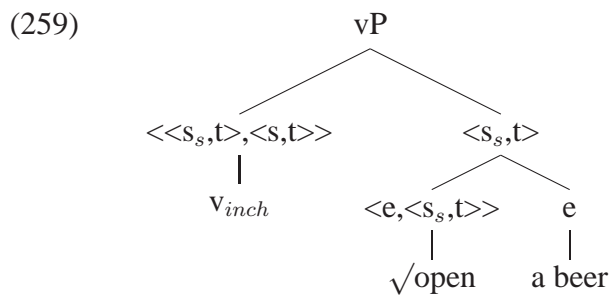

The unavailability of pseudo-resultatives with inchoative verbs follows from the fact that again there is no subconstituent of the verb which is a predicate of individuals for the pseudo-resultative to modify. Resultatives are possible as modifiers of the direct object instead.

The availability of applicatives with inchoative verbs can be explained as with explicit creation verbs above. The direct object position provides an appropriate site for merger of the APPL head, even though this position is in the complement of the root. This is because the root is of type $\langle e, \langle s, t \rangle \rangle$, the same type the APPL head takes as a second argument. This is illustrated in (260):

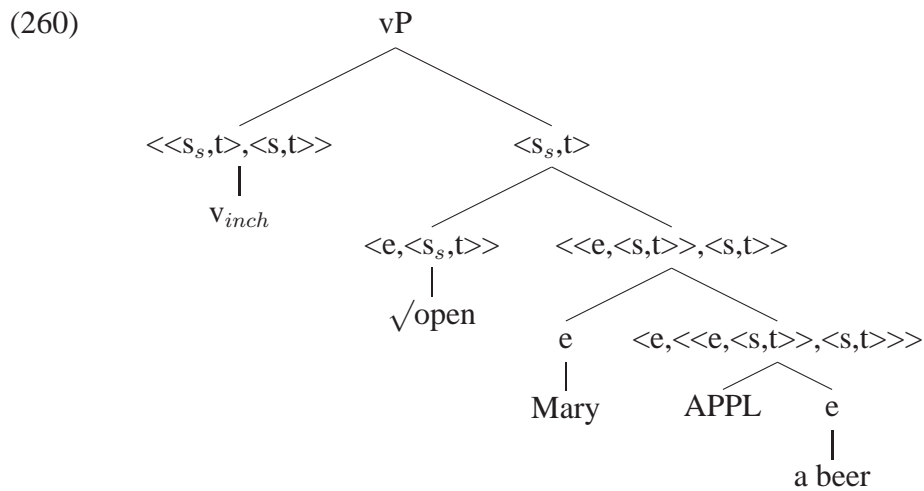

6.1.3 Summary

In sum, in order to capture contrasts between verbs which are all derived from roots which are syntactically category-neutral, it is necessary to make recourse to their semantic type. This has been shown to be a desirable move, since both syntactic and semantic generalizations have been shown to depend on the root type. The semantic generalizations are directly derived from the argument structure and composition of the root with other elements, while syntactic generalizations arise because of the semantic restrictions on the composition which lead to different structural contexts for different types of roots.

6.2 The Analysis of Resultatives

In chapters 2 and 3 it was argued that there is a class of pseudo-resultative predicates which is superficially similar to the class resultative predicates, but semantically and syntactically distinct. Since such predicates have previously been treated as belonging to the resultative class, this distinction has consequences for the range of data that analyses of resultative predicates must account for.

The contrast supports the claim of Mateu (2000) that resultative APs are lacking in Romance languages, as the examples he analyzes as ‘adverbial’ (107) can be subsumed under the current analysis of pseudo-resultatives. The contrast similarly adds credence to Kratzer’s (2005) argument that apparent resultatives occurring with obligatorily transitive verbs are not in fact resultatives at all. For one, this analysis is also supported by an explicit account for the predicates that Kratzer argues as ‘adverbial’. Further, it has been shown that the obligatorily transitive implicit creation verbs in fact do not co-occur with resultative predicates. These verbs, which are derived from roots which require a relational structure, differ in this respect from verbs where the root is a manner modifier, such as explicit creation verbs. However, it is not clear from this perspective what the analysis of apparent resultatives which occur with inchoative verbs should be, since the roots of such verbs in the usual case are argued to combine directly with an argument, such that they would seem to be obligatorily transitive.

Despite the differences between resultatives and pseudo-resultatives argued for here, both show a particular restrictiveness in possible modifier/modified pairs which varies across languages. It is an open research area to determine what it is exactly about the semantics of these modifiers that spans these different constructions and leads to such constraints.

6.3 The Analysis of Particles

It was shown in chapter 3 that the presence of aspectual verb particles like *up* and *out* degrades the judgments of sentences with resultative predicates more than those with pseudo-resultative predicates. This not only tells us about the differences between resultatives and pseudo-resultatives, but also about the analysis of these particles as well.

One possible hypothesis for this observed degradation of judgments that has been proposed in literature is that verb particles and resultatives are merged in the same position, and are essentially the same type of syntactic and semantic element (Kayne 1985, Neeleman 1994, Ramchand 2006). However, the data presented in chapter 3 argue against this analysis, at least for aspectual particles. If these were the same as resultatives, then one would expect their patterns of co-occurrence with pseudo-resultatives to be the same. However, while particles in combination with pseudo-resultatives are relatively good, resultatives and pseudo-resultative do not felicitously co-occur. This would be unexpected if particles and resultatives were the same type of element. Thus the data suggest that an alternative analysis for this incompatibility between resultatives and aspectual particles is necessary. Further work is necessary to determine the correct alternative.

6.4 Conclusion

In this dissertation, I have argued that implicit creation verbs are semantically complex, and that they are derived from roots which are predicates of individuals - the same roots that derive the nouns that they are related to. This account allows for a semantic account of pseudo-resultative modification. I have further shown that there is independent evidence for a syntactic decomposition for such verbs that parallels the semantic decomposition. This conclusion, along with a compositional analysis of pseudo-resultatives,

provides support for a transparent compositional relationship between the syntax and the semantics. The compositional analysis of pseudo-resultatives provides insight into the analysis of resultatives, aspectual verb particles, and bracketing paradoxes in Japanese. It was shown that different types of roots can be embedded in different syntactic contexts, and that this follows from the combinatorial restrictions imposed by the root types themselves.

I have argued for an approach to lexical roots that falls between that of Borer (2005a, 2005b) and Ramchand (2006). Specifically, I have proposed that roots must be specified for at least semantic type and denotation, but that one root may in a particular language map to more than one denotation. This system is thus more constrained with respect to root semantics than Borer's approach, but freer than Ramchand's. This freedom is also what enables a formal account for the relatedness between the different meanings of polysemous words. It remains an open question whether there is a derivational relationship between the multiple denotations of a root, and thus whether such derivations can also be formally constrained.

The approach presented here builds on the work of Hale and Keyser (1993, 2002), but differs crucially in deriving similar contrasts from semantic type, rather than from syntactic category. Thus, while Hale and Keyser assume primitive differences between the projection of nouns and verbs, I argue that these argument structural contrasts can largely be derived from root type and constraints on composition.

In sum, it has been shown that the syntax and argument structure of a verb can be correlated with the type of its lexical root. Thus, if we want to understand the ways in which meaning predicts syntax and argument structure, we cannot draw generalizations over 'verbs' like *braid*, which are ambiguous with respect to type. Rather, we crucially need to control for the root type and syntactic decomposition of the verb in a given environment.

Appendix: Experiment Stimuli

RV-NoPred-NoPart

1. In fifteen minutes, Bill cooked the tomatoes.
2. In minutes, Chris cut the packages.
3. In ten minutes, Mary smoothed the ribbons.
4. In one day, Anna painted the door.
5. In three minutes, Sarah grilled the steak.
6. In a few minutes, George fried the ginger.

RV-NoPred-Part1

7. In ten minutes, Mary smoothed out the ribbons.
8. In one day, Anna painted up the door.
9. In three minutes, Sarah grilled up the steak.
10. In a few minutes, George fried up the ginger.
11. In fifteen minutes, Bill cooked up the tomatoes.

12. In minutes, Chris cut up the packages.

RV-NoPred-Part2

13. In ten minutes, Mary smoothed the ribbons out.

14. In one day, Anna painted the door up.

15. In three minutes, Sarah grilled the steak up.

16. In a few minutes, George fried the ginger up.

17. In fifteen minutes, Bill cooked the tomatoes up.

18. In minutes, Chris cut the packages up.

RV-Pred-NoPart

19. In three minutes, Sarah grilled the steak black.

20. In a few minutes, George fried the ginger black.

21. In fifteen minutes, Bill cooked the tomatoes dry.

22. In minutes, Chris cut the packages open.

23. In ten minutes, Mary smoothed the ribbons flat.

24. In one day, Anna painted the door red.

RV-Pred-Part1

25. In three minutes, Sarah grilled up the steak black.

26. In a few minutes, George fried up the ginger black.

27. In fifteen minutes, Bill cooked up the tomatoes dry.

28. In minutes, Chris cut up the packages open.
29. In ten minutes, Mary smoothed out the ribbons flat.
30. In one day, Anna painted up the door red.

RV-Pred-Part2

31. In fifteen minutes, Bill cooked the tomatoes up dry.
32. In minutes, Chris cut the packages up open.
33. In ten minutes, Mary smoothed the ribbons out flat.
34. In one day, Anna painted the door up red.
35. In three minutes, Sarah grilled the steak up black.
36. In a few minutes, George fried the ginger up black.

ICV-NoPred-NoPart

37. In one minute, Jane braided the ribbons.
38. In a minute, Dan opened the door.
39. In a few moments, Laura sliced the steak.
40. In a few seconds, Kara ground the ginger.
41. In two minutes, Tom chopped the tomatoes.
42. In one hour, Frank piled the packages.

ICV-NoPred-Part1

43. In one minute, Jane braided up the ribbons.

44. In a minute, Dan opened up the door.
45. In a few moments, Laura sliced up the steak.
46. In a few seconds, Kara ground up the ginger.
47. In two minutes, Tom chopped up the tomatoes.
48. In one hour, Frank piled up the packages.

ICV-NoPred-Part2

49. In a few moments, Laura sliced the steak up.
50. In a few seconds, Kara ground the ginger up.
51. In two minutes, Tom chopped the tomatoes up.
52. In one hour, Frank piled the packages up.
53. In one minute, Jane braided the ribbons up.
54. In a minute, Dan opened the door up.

ICV-Pred-NoPart

55. In a few moments, Laura sliced the steak thin.
56. In a few seconds, Kara ground the ginger fine.
57. In two minutes, Tom chopped the tomatoes fine.
58. In one hour, Frank piled the packages high.
59. In one minute, Jane braided the ribbons tight.

60. In a minute, Dan opened the door wide.

ICV-Pred-Part1

61. In two minutes, Tom chopped up the tomatoes fine.

62. In one hour, Frank piled up the packages high.

63. In one minute, Jane braided up the ribbons tight.

64. In a minute, Dan opened up the door wide.

65. In a few moments, Laura sliced up the steak thin.

66. In a few seconds, Kara ground up the ginger fine.

ICV-Pred-Part2

67. In two minutes, Tom chopped the tomatoes up fine.

68. In one hour, Frank piled the packages up high.

69. In one minute, Jane braided the ribbons up tight.

70. In a minute, Dan opened the door up wide.

71. In a few moments, Laura sliced the steak up thin.

72. In a few seconds, Kara ground the ginger up fine.

Anomalous

73. In three minutes, Sarah smiled the ham up.

74. In ten minutes, Mary put the strings.

75. In one minute, Jane pressed the ropes up tight.

76. In two minutes, Tom ran up the tomatoes fine.

77. In a minute, Dan walked the gate wide.

78. In one hour, Frank smelled up the envelopes.

Bibliography

- Alexiadou, Artemis, Elena Anagnostopoulou, and Florian Schäfer. 2006. The properties of anticausatives crosslinguistically. In *Phases of interpretation*, ed. M. Frascarelli. Berlin: Mouton. 113
- Arad, Maya. 2003. Locality constraints on the interpretation of roots: The case of Hebrew denominal verbs. *Natural Language and Linguistic Theory* 21:737–778. 105, 106, 107
- Arad, Maya. 2005. *Roots and patterns: Hebrew morpho-syntax*. Springer. 13, 14
- Asano, Yukiko. 2004. Deceptive word-formation in Japanese. MS, Stonybrook University. 130, 131, 134, 136, 137, 140, 144
- Baker, Mark C. 1988. *Incorporation: A theory of grammatical function changing*. Chicago: University of Chicago Press. 8, 9, 136
- Barner, David, and Alan Bale. 2002. No nouns, no verbs: Psycholinguistic arguments in favor of lexical underspecification. *Lingua* 112:771–791. 14
- Barner, David, and Alan Bale. 2005. No nouns, no verbs? A rejoinder to Panagiotidis. *Lingua* 115:1169–1179. 14
- Beck, Sigrid, and Kyle Johnson. 2004. Double objects again. *Linguistic Inquiry* 35:97–124. 55

- Borer, Hagit. 2005a. *In name only*, volume I of *Structuring Sense*. Oxford University Press. 14, 146, 156
- Borer, Hagit. 2005b. *The normal course of events*, volume II of *Structuring Sense*. Oxford University Press. 14, 156
- Carrier, J., and J. Randall. 1992. The argument structure and syntactic structure of resultatives. *Linguistic Inquiry* 23:173–234. 76
- Chierchia, Gennaro. 1998. Plurality of mass nouns and the notion of semantic parameter. In *Events and grammar*, ed. Susan Rothstein. Dordrecht: Kluwer. 28
- Chomsky, Noam. 1995. *The minimalist program*. MIT Press. 50, 69, 125, 144
- Chomsky, Noam. 2000. Minimalist inquiries: The framework. In *Step by step: Essays on minimalist syntax in honor of Howard Lasnik*, ed. Roger Martin, David Michaels, and Juan Uriagereka, 89–156. Cambridge, MA: MIT Press. 125, 141
- Chomsky, Noam. 2001a. Beyond explanatory adequacy. In *MIT occasional papers in linguistics*, volume 20. Cambridge, MA: MIT Working Papers in Linguistics. Published 2004. 125, 141
- Chomsky, Noam. 2001b. Derivation by phase. In *Ken Hale: A life in language*, ed. Michael Kenstowicz. MIT Press. 103, 141
- Clark, E.V., and H.H. Clark. 1979. When nouns surface as verbs. *Language* 55:767–811. 18, 19, 20, 21, 42, 43
- Corver, Norbert. 2005. Copular -ly. Ms., UiL-OTS, Utrecht University, November 2005. 36, 74

- Davidson, Donald. 1967. The logical form of action sentences. In *The logic of decision and action*, ed. Nicholas Rescher. University of Pittsburgh Press. 37
- Dikken, Marcel den. 1995. *Particles*. New York: Oxford University Press. 87
- Don, Jan. 2005. Roots, deverbal nouns and denominal verbs. In *Morphology and linguistic typology: On-line proceedings of the fourth Mediterranean Morphology Meeting (mmm4) Catania, September 21-23, 2003*, ed. G. Booij, E. Guevara, A. Ralli, S. SgROI, and S. Scalise. University of Bologna. URL <http://morbo.lingue.unibo.it/mmm/>. 105
- Dowty, David. 1979. *Word meaning and Montague Grammar: The semantics of verbs and times in generative semantics*. Dordrecht: Reidel. 6, 7, 8, 23, 55
- Embick, David. 2006. Linearization and local dislocation: Derivational mechanics and interactions. *Linguistic Analysis* . 130, 144
- Embick, David, and Rolf Noyer. 1999. Locality in post-syntactic operations. In *Papers on morphology and syntax, cycle two*, ed. V. Lin, C. Krause, B. Bruening, and K. Arregi, volume 34. MITWPL. 135
- Embick, David, and Rolf Noyer. 2001. Movement operations after syntax. *Linguistic Inquiry* 32:555–595. 130, 135, 144
- Emonds, Joseph. 1985. *A unified theory of syntactic categories*. Dordrecht: Foris. 74
- Fong, Vivienne. 2001. ‘Into doing something’: Where is the path in event predicates? Paper presented at the ESSLLI 2000 Workshop on Paths and Telicity in Event Structure, University of Birmingham, 7-11 August 2000. 79

- Geuder, Wilhelm. 2000. Oriented adverbs: Issues in the lexical semantics of event adverbs. Doctoral Dissertation, Universität Tübingen. 17, 32, 37, 38, 39, 42, 44, 65, 74
- Hale, Kenneth, and Samuel Jay Keyser. 1993. On argument structure and the lexical expression of syntactic relations. In *The view from building 20*, ed. Kenneth Hale and Samuel Jay Keyser, Current Studies in Linguistics, chapter 2, 53–110. Cambridge, MA: MIT Press. 2, 3, 4, 8, 10, 24, 30, 46, 49, 112, 156
- Hale, Kenneth, and Samuel Jay Keyser. 2002. *Prolegomenon to a theory of argument structure*. Cambridge, MA: MIT Press. 3, 8, 10, 46, 156
- Halle, Morris, and Alec Marantz. 1993. Distributed morphology and the pieces of inflection. In *The view from building 20: Essays in honor of Sylvain Bromberger*, ed. Kenneth Hale and Samuel J. Keyser, 111–176. Cambridge, MA: MIT Press. 10, 13, 130
- Harley, Heidi. 1995. Subject, events, and licensing. Doctoral Dissertation, MIT. 110, 152
- Harley, Heidi. 2002. Possession and the double object construction. In *Yearbook of linguistic variation*, ed. Pierre Pica and Johan Rooryck, volume 2. Amsterdam: John Benjamins. 22
- Harley, Heidi. 2005. How do verbs get their names? denominal verbs, manner incorporation, and the ontology of verb roots in English. In *The syntax of aspect*, ed. Nomi Erteschik-Shir and Tova Rapoport. Oxford University Press. 9, 22, 23, 24, 25, 26, 27, 29, 46
- Heim, Irene, and Angelika Kratzer. 1998. *Semantics in generative grammar*. Malden, MA: Blackwell. 14

- Hoekstra, Teun. 1988. Small clause results. *Lingua* 74:101–139. 76
- Jackendoff, Ray. 1977. *X-bar syntax: A study of phrase structure*. Cambridge: MIT Press. 87
- Jackendoff, Ray. 1991. Parts and boundaries. *Cognition* 41:9–45. 23, 25, 27
- Jackendoff, Ray. 1996. The proper treatment of measuring out, telicity, and perhaps even quantification in english. *Natural Language and Linguistic Theory* 14:305–54. 23
- Kageyama, Taro. 1982. Word formation in Japanese. *Lingua* 57:215–258. 131
- Karlsson, Fred. 1999. *Finnish: an essential grammar*. Routledge. 81
- Kayne, Richard S. 1985. Principles of particle constructions. In *Grammatical representation*, ed. Jacqueline Guéron, Hans-Georg Obenauer, and Jean-Yves Pollock, 101–140. Dordrecht: Foris. 75, 88, 155
- Kayne, Richard S. 1994. *The antisymmetry of syntax*. Cambridge, MA: MIT Press. 10
- Kester, Ellen-Petra. 1996. *The nature of adjectival inflection*. Utrecht. 84
- Keyser, Samuel J., and Thomas Roeper. 1992. Re: The abstract clitic hypothesis. *Linguistic Inquiry* 23:89–125. 58
- Kiparsky, Paul. 1982. Word-formation and the lexicon. In *Proceedings of the Mid-American Linguistics Conference*. Lawrence, Kansas. 103, 104, 107
- Kitagawa, Yoshihisa. 1986. More on bracketing paradoxes. *Linguistic Inquiry* 17:177–183. 129, 130, 131, 132, 133, 134
- Kracht, Marcus. 2002. On the semantics of locatives. *Linguistics and Philosophy* 25:157–232. 48, 49, 50, 52, 79

- Kratzer, Angelika. 1996. Severing the external argument from its verb. In *Phrase structure and the lexicon*, ed. Johan Rooryck and Laurie Zaring, 109–137. Dordrecht: Kluwer. 15, 149
- Kratzer, Angelika. 2000. Building statives. In *Proceedings of the 26th Annual Meeting of the Berkeley Linguistics Society*, ed. Lisa J. Conathan et al., 385–399. Berkeley, CA. 9
- Kratzer, Angelika. 2005. Building resultatives. In *Event arguments in syntax, semantics, and discourse*, ed. Claudia Maienborn and Angelika Wöllenstein-Leisten, 177–212. Tübingen: Niemeyer. 32, 36, 65, 67, 76, 154
- Krifka, Manfred. 1989. Nominal reference, temporal constitution, and quantification in event semantics. In *Semantics and contextual expressions*, ed. Renate Bartsch, Johann van Benthem, and Peter van Emde Boas, 75–115. Dordrecht: Foris. 23
- Lakoff, George. 1968. Instrumental adverbs and the concept of deep structure. *Foundations of Language* 4:4–29. 6
- Larson, Richard. 1991. Some issues in verb serialization. In *Serial verbs: Grammatical, comparative and cognitive approaches*, ed. Claire Lefebvre, 185–210. Amsterdam: Benjamins. 76
- Legate, Julie Anne. 2003. Some interface properties of the phase. *Linguistic Inquiry* 34:506–516. 141
- Levin, Beth. 1993. *English verb classes and alternations: A preliminary investigation*. Chicago: University of Chicago Press. 18
- Levin, Beth, and Malka Rappaport-Hovav. 1995. *Unaccusativity: At the syntax-lexical semantics interface*. Cambridge, MA: MIT Press. 6, 8

- Marantz, Alec. 1981. On the nature of grammatical relations. Doctoral Dissertation, MIT. 10
- Marantz, Alec. 1989. Projection vs. percolation in the syntax of synthetic compounds. In *Selected Papers from the Annual Spring Colloquium*, 95–112. Chapel Hill: University of North Carolina, UNC Linguistics Circle. 76
- Marantz, Alec. 1997. No escape from syntax: Don't try morphological analysis in the privacy of your own lexicon. In *Proceedings of the 21st annual Penn Linguistics Colloquium*, ed. A. Dimitriadis, L. Siegel, C. Surek-Clark, and A. Williams, volume 42, 201–225. Philadelphia: University of Pennsylvania Working Papers in Linguistics. 4, 10, 13, 14
- Marantz, Alec. 2000. Roots: The universality of root and pattern morphology. Paper presented at the conference on Afro-Asiatic languages, University of Paris VII. 103, 105, 106, 107
- Marantz, Alec. 2005. Objects out of the lexicon! Argument-structure in the syntax. Handout, University of Connecticut Linguistics Colloquium, April 2005. 115, 148
- Marantz, Alec. 2006. Phases and words. MS, NYU, November 2006. 103, 141
- Marantz, Alec. 2007. Restitutive re- and the first phase syntax/semantics of the VP. Handout, Maryland. 56, 58, 60, 111
- Mateu, Jaume. 2000. *Why Can't We Wipe the Slate Clean?* A lexical-syntactic approach to resultative constructions. *Catalan Working Papers in Linguistics* 8:71–95. 32, 36, 67, 68, 86, 87, 154

- Meyer, D.E., and R.W. Schvaneveldt. 1971. Facilitation in recognizing pairs of words: Evidence of a dependence between retrieval operations. *Journal of Experimental Psychology* 90:227–234. 2
- Napoli, D. 1992. Secondary resultative predicates in Italian. *Journal of Linguistics* 28:53–90. 34, 65
- Neeleman, Ad. 1994. Complex predicates. Doctoral Dissertation, Utrecht University. 76, 77, 90, 155
- Nunberg, Geoffrey. 1995. Transfers of meaning. *Journal of Semantics* 12:109–132. 40
- Osswald, Rainer. 2005. On result nominalization. In *Proceedings of Sinn und Bedeutung* 9, ed. Emar Maier, Corien Bary, and Janneke Huitink, 256–270. Nijmegen: NCS. 17
- Parsons, Terence. 1990. *Events in the semantics of English*. Cambridge, MA: MIT Press. 6, 8, 37, 112
- Pesetsky, David. 1985. Morphology and logical form. *Linguistic Inquiry* 16:193–246. 130
- Pesetsky, David. 1995. *Zero syntax: Experiencers and cascades*. Cambridge, MA: The MIT Press. 14
- Pustejovsky, James. 1991. The syntax of event structure. *Cognition* 41:47–81. 25
- Pustejovsky, James. 1995. *The generative lexicon*. Cambridge, MA: MIT Press. 8
- Pylkkänen, Liina. 2002. Introducing arguments. Doctoral Dissertation, MIT. 64, 112, 113, 121, 124

- Ramchand, Gillian. 2006. Verb meaning and the lexicon: A first phase syntax. MS, University of Tromsø. 2, 4, 89, 155, 156
- Rimell, Laura. 2006. The syntax and semantics of grammatical category flexibility: A cross-linguistic perspective. Dissertation Proposal, NYU, March 20, 2006. 105, 107
- Sadler, Louisa, and Douglas J. Arnold. 1994. Prenominal adjectives and the phrasal/lexical distinction. *Journal of Linguistics* 30:187–226. 71
- Stechow, Arnim von. 1996. The different readings of *wieder* ‘again’: A structural account. *Journal of Semantics* 13:87–138. 54, 56
- Sugioka, Y., and R. Lehr. 1983. Adverbial -ly as an inflectional affix. In *Papers from the parasession on the interplay of phonology, morphology and syntax*, ed. J. Richardson, M. Marks, and A. Chukerman, 293–300. Chicago: Chicago Linguistic Society. 74
- Talmy, Leonard. 1991. Paths to realization: A typology of event integration. In *Buffalo working papers in linguistics*, volume 91, 147–187. Buffalo, NY: SUNY Buffalo Linguistics. 87
- Tenny, Carol. 1987. Grammaticalizing aspect and affectedness. Doctoral Dissertation, MIT. 23
- Tenny, Carol. 2000. Core events and adverbial modification. In *Events as grammatical objects: The converging perspectives of lexical semantics and syntax*, ed. Carol Tenny and James Pustejovsky. Stanford: Center for the Study of Language and Information. 113
- Vendler, Zeno. 1967. *Linguistics in philosophy*. Ithaca: Cornell University Press. 7

- Verkuyl, Henk. 1993. *A theory of aspectuality: The interaction between temporal and atemporal structure*. Cambridge Studies in Linguistics. Cambridge: Cambridge University Press. 7
- Volpe, Mark. 2005. Japanese morphology and its theoretical consequences: Derivational morphology in Distributed Morphology. Doctoral Dissertation, SUNY Stony Brook. 138
- Washio, Ryuichi. 1997. Resultatives, compositionality and language variation. *Journal of East Asian Linguistics* 6:1–49. 32, 34, 36, 67, 68
- Wheeler, Max W., Alan Yates, and Nicholas Dols. 1999. *Catalan: A comprehensive grammar*. London/New York: Routledge. 69